

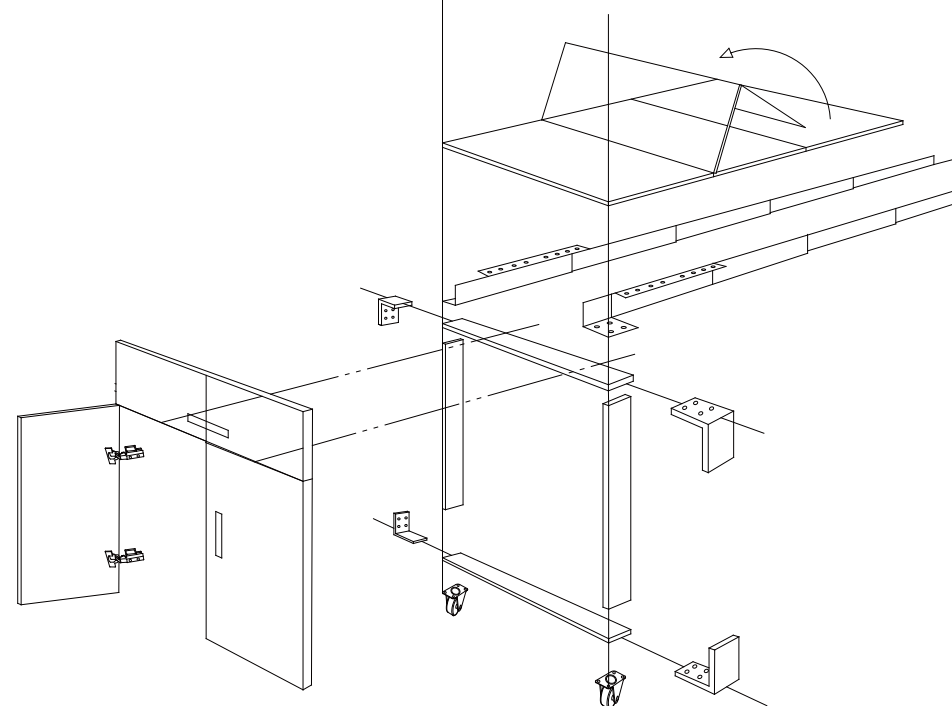

億 誼 五 金

ESHINE INDUSTRIAL CO., LTD.

When
Only
The Best
Will Do



台灣總公司 TAIWAN
彰化縣花壇鄉口庄街101巷16弄61號
TEL: 886-4-7862423 (代表號)
FAX: 886-4-7862224
E-mail: es@hsec.com.tw

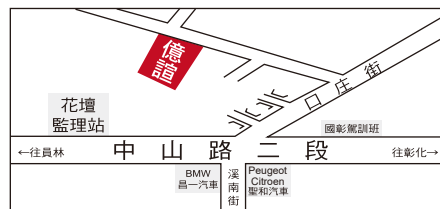

台北展示中心 TAIPEI
新北市三峽區三樹路222巷196之30號
TEL: 886-2-86716300 (代表號)
FAX: 886-2-86716228
E-mail: es.yu@msa.hinet.net

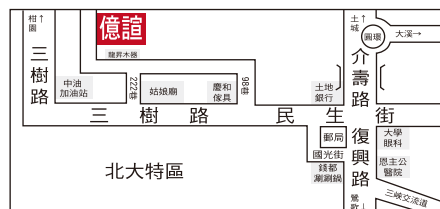







<http://www.ehshine.com.tw>



2023







<<< 新增產品 >>>>



Model NO.						
	275	450	70	20		
A805-1	425	600	70	20		
	575	900	70	20		
	975	1200	70	20		

COLOR: BK 正面鎖



Model NO.						
	275	450	70	20		
A805	425	600	70	20		
	575	900	70	20		
	975	1200	70	20		

COLOR: BK 對鎖









Model NO.	Φ	∅	mm	mm	mm
A807	198x48	202x52	14		

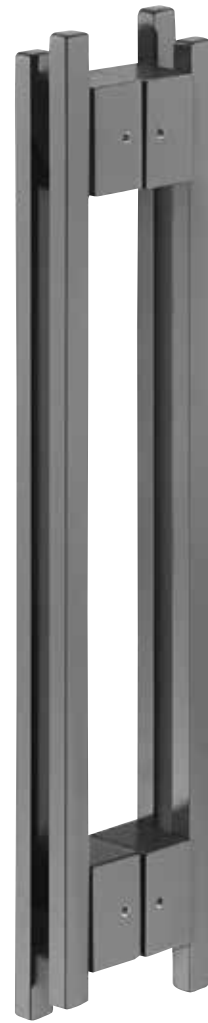
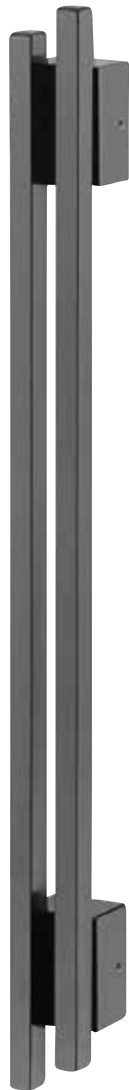



COLOR: SB

Model NO.	Φ	∅	mm	mm	mm
A808	171x52	176x56	14		

COLOR: BK+SB 皮把手



Model NO.					
	224		304	38	32
A799-1	320		400	38	32
	425		505	38	32
COLOR : SC.GSB 正面鎖					

Model NO.					
	224		304	38	32
A799	320		400	38	32
	425		505	38	32
COLOR : SC.GSB 對鎖					



Model NO.					
	160		190	28	20
A800-1	224		254	28	20
	320		360	28	20
COLOR: SC.GSB 正面鎖					

Model NO.					
	160		190	28	20
A800	224		254	28	20
	320		360	28	20
COLOR: SC.GSB 對鎖					



Model NO.					
ZS960	單孔	33	27		
COLOR : BSN+BK					



Model NO.					
ZS960	單孔	33	27		
COLOR : GP+CF					



Model NO.					
Z875	96	120	20	25	
	128	152	20	25	
COLOR : BSN+BK					



Model NO.					
Z875	96	120	20	25	
	128	152	20	25	
COLOR : GP+CF					



Model NO.					
Z880	32	84	21	35	
COLOR : BPB					



Model NO.					
ZS963	單孔	30	28		
COLOR : BPB					

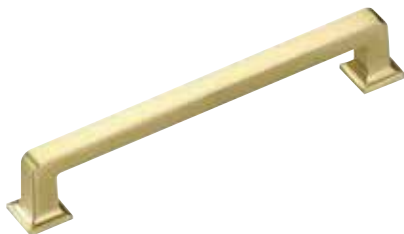

Model NO.					
Z877	96	117	30	18	
	128	150	30	18	
	160	182	30	18	
COLOR : BPB					

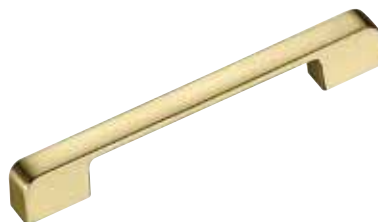

Model NO.					
Z878	96	106	21	12	
	128	138	21	12	
	160	170	21	12	
COLOR : BPB					



Model NO.					
Z879	96	114	27	19	
	128	146	27	19	
	192	210	27	20	
COLOR : BPB					

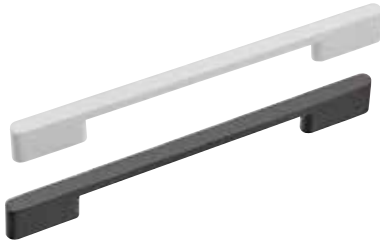

Model NO.				
128/160		180	26	13
A810		192/224	280	26 13
		320/480	500	26 13

COLOR : GSB、GHWT



Model NO.				
Z873	96	115	35	20
	128	147	35	20

COLOR : SB



Model NO.				
A811		50	6	45
		90	6	45
		150	6	45

COLOR : GSB



Model NO.				
A812		50	6	45
		90	6	45
		150	6	45

COLOR : GSB



Model NO.				
S959	單孔	40x40		20

COLOR : WT+BK



Model NO.				
S959	單孔	40x40		20

COLOR : BK+BK



Model NO.				
S959	單孔	40x40		20

COLOR : BK+WT



Model NO.				
ZS961	單孔	71		28

COLOR : BK



Model NO.				
ZS962	單孔	18		22

COLOR : SB



Model NO.				
Z876	96	105	30	10
	128	137	30	10

COLOR : SB



Model NO.		\varnothing			
- S 單孔		27		20	
S955 - M 單孔		33		24	
- L 單孔		39		28	
COLOR: WT					陶瓷



Model NO.		\varnothing			
ZS953 單孔		37		29	
COLOR: WBK					



Model NO.		\varnothing			
ZS952 單孔		38		35	
COLOR: GCK					



Model NO.		\varnothing			
Z787	96	112	41	15	
	128	145	43	15	
COLOR: WBK					



Model NO.		\varnothing			
Z788	96	112	41	15	
	128	145	43	15	
COLOR: GCK					



Model NO.		\varnothing			
Z789	96	135	28	22	
	128	176	31	22	
COLOR: WBK					



Model NO.		\varnothing			
Z790	96	135	28	22	
	128	176	31	22	
COLOR: GCK					



Model NO. **A793** 32 65X65 30
COLOR: GHWT 正面鎖/對鎖



Model NO. **A793** 32 65X65 30
COLOR: SC 正面鎖/對鎖

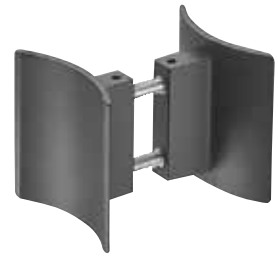

Model NO. **A793** 32 65X65 30
COLOR: GSB 正面鎖/對鎖



Model NO. **ZS951** 單孔 33 28
COLOR: AG



Model NO. **ZS237** 單孔 30 25
COLOR: PC+GP



Model NO. **Z851** 128 153 39 24
160 184 39 24
COLOR: AG



Model NO. **Z794** 96 117 23 15
COLOR: PC+GP



Model NO. **Z852** 96 113 41 22
128 143 42 22
COLOR: AG







Model NO. **Z794** 128 155 24 15
COLOR: PC+GP



Model NO.					
ZS910	單孔	31		30	





COLOR: BK.HAB



Model NO.					
Z853	96	148	22	30	
	128	180	24	30	





COLOR: BK.HAB



Model NO.					
Z854	128	170	24	22	
	192	231	26	24	
	256	303	27	24	





COLOR: BK.HAB



Model NO.					
Z856	96	135	23	20	
	128	170	24	22	





COLOR: BK.HAB



Model NO.					
Z857	96	120	22	15	
	128	152	23	16	





COLOR: BK



Model NO.					
Z858	96	130	26	15	
	128	160	26	16	





COLOR: BK.HAB



Model NO.					
Z791	96	148	21	20	
	128	178	25	21	
	256	328	31	28	

COLOR: BK+GP、GWT+GP



Model NO.					
Z859	96	127	28	27	
	128	160	28	29	

COLOR: HAB



Model NO.	
ZS909	單孔 64 19
COLOR:	PC



Model NO.	
Z860	85 92x16 100x22 38
COLOR:	BSN



Model NO.	
Z874	85 92x16 104x22 38
COLOR:	SG、SB

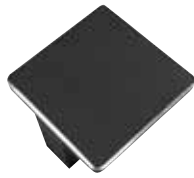

Model NO.	
A801	32 60 25 60
COLOR:	BK



Model NO.	
A802	128 139 25 35
	160 171 25 35
COLOR:	BK

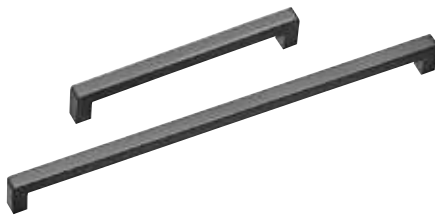

Model NO.	
	128 140 30 12
	160 172 30 12
A803	224 236 30 12
	320 332 30 12
	480 492 30 12
COLOR:	BK



Model NO.	
	128 153 28 25
A804	160 186 28 25
	224 250 28 25
COLOR:	GHWT、GSB



Model NO.	
	160 214 30 20
Z797	192 246 30 20
	256 310 30 20
COLOR:	AB、PC



Model NO.	
	160 168 27 14
Z798	192 211 27 14
	256 273 27 14
COLOR:	AB、PC

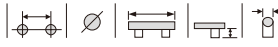

Model NO. 
Z867 單孔 41x41 45x45 12
 COLOR: SB

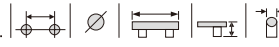

Model NO. 
ZS956 單孔 32x32 25
 COLOR: SB

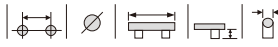

Model NO. 
ZS130 46x19 50x24 9
 COLOR: GBK、SN

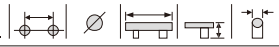

Model NO. 
A792

	50	9	32
	90	9	32
	150	9	32

 COLOR: SC、GSB



Model NO. 
Z474

96	116x37	120x41	10
128	148x36	152x41	10

 COLOR: GSB、GSC

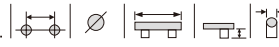

Model NO. 
A750

96	107x29	116x38	10
128	141x29	150x38	10

 COLOR: GWT、GSB、SC、BSN

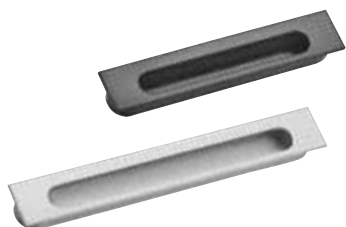

Model NO. 
A795

96	112x24	118x30	11
128	144x24	150x30	11
160	176x24	182x30	11

 COLOR: GSB、SC



Model NO. 
A796

96	107x12	111x16	11
128	139x12	143x16	11
160	171x12	175x16	11

 COLOR: GSB、SC (適用推門)



Model NO.	
ZS957	單孔 30x30 25
COLOR: SB	



Model NO.	
ZS958	單孔 34 25
COLOR: SB	



Model NO.	
Z863	96 144 32 19
	128 176 32 19
COLOR: SB	



Model NO.	
Z862	96 116 24 19
	128 152 24 19
COLOR: SB	



Model NO.	
Z865	96 113 28 12
	128 145 28 12
COLOR: SB	



Model NO.	
Z864	96 110 33 15
	128 142 33 15
COLOR: SB	



Model NO.	
Z866	96 111 28 11
	128 144 28 11
COLOR: SB	



Model NO.	
A519	128 148 28 12
	160 180 28 12
	224 245 28 12
	320 340 28 12
COLOR: GHWT、SC、GSB	

F38B

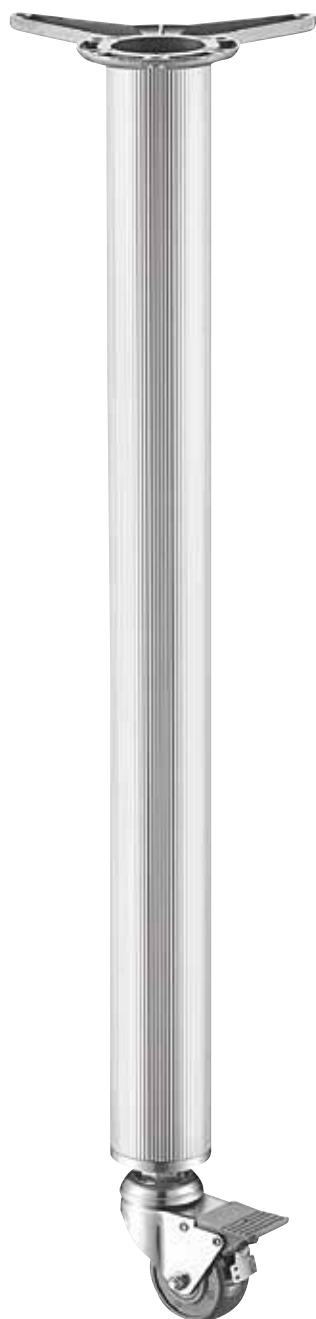

Model NO.	Height	Width	Mounting Plate	Castor Wheel
F38-B	730	60		
COLOR: SC、黑		活動輪桌腳(可訂製) 高度可調1.5cm		



Model NO.	Height	Width	Mounting Plate	Castor Wheel
AF36	79	25		
COLOR: 黑、SC		高度可訂製		



Model NO.	Height	Width	Mounting Plate	Castor Wheel
AF35	79	38		
COLOR: 黑、SC		高度可訂製		



Model NO.	Height	Width	Mounting Plate	Castor Wheel
AF34	70	79	51	
	100	79	51	
	130	79	51	
COLOR: SC		高度可訂製		

H15B 窄鋁框鉸鏈(緩衝)

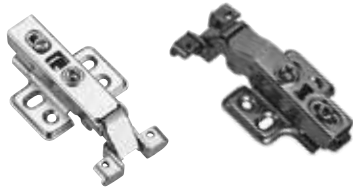

● 產品對照表 ●

品 編	規 格
H15B36	蓋 6 分
H15B33	蓋 3 分
H15B30	入 柱

※ 4 孔底座

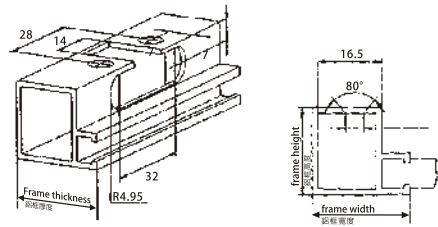

H21 厚門緩衝鉸鏈



● 產品對照表 ●

品 編	規 格
H213503-6	蓋 6 分
H213503-3	蓋 3 分
H213503-0	入 柱

- 開啟角度 110°
- 杯孔距 52mm
- 鉸杯厚度 15mm
- 鉸杯直徑 40mm
- 門板(K)尺寸 4~5mm
- 門可選用板厚 24~28mm

- Opening angle 110°
- Hole space of hinge cup 52mm
- Depth of hinge cup 15mm
- Diameter of hinge cup 40mm
- Door dimension (K) 4~5mm
- Range of doors thickness 24~28mm

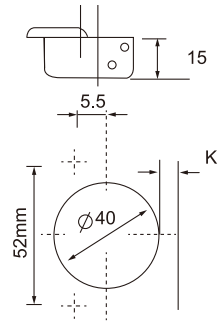

HT4502 三節微緩衝抽中滑軌

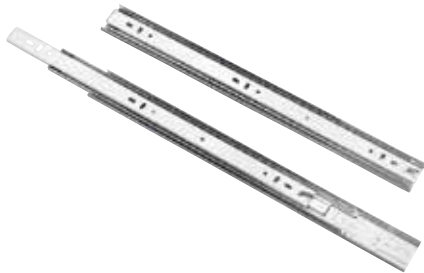

★ 三節微緩衝抽中滑軌

- 長度 : 350、400、450 mm
- 安裝 : 側面安裝、間隙 12.6mm
- 承重 : 45Kg/450mm(18")
- 表面 : 鍍白鋅
- 優點 : 全拉出靜音滑軌, 輕巧的自鎖關閉裝置可自動地使抽屜達到緊閉效果, 防止抽屜意外打開。輕鬆的滑入安裝設計與鎖定設計, 更具易裝易拆的功能。

★ Auto-Return Three Fold Steel Ball Slide

- Length : 350、400、450 mm
- Install : side install ,interval 12.6 mm
- Load : 45kg/450mm(18")
- Surface : Galvanized-zinc
- Advantage : Full-drawing silent voice slide, Simple self-locked -closed device may be drawing automatic to reach closed effect prevent drawer open by accident. Flexible slide and controlled design had easily installed and dismantled function.

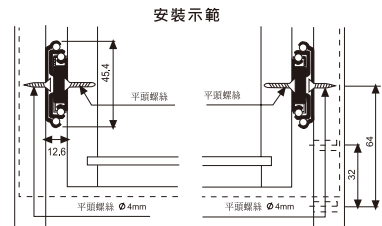

安裝寬度 12.6 mm, 誤差調節+0.2mm
Width 12.6 mm Error Adjustable Flat Screw+0.2mm

HT4536 新型三節緩衝滑軌



★ 新型三節緩衝滑軌

- 長度 : 300、350、400、450、500 mm
- 安裝 : 側面安裝、間隙 13mm
- 承重 : 35Kg/450mm(18")
- 表面 : 鍍白鋅
- 優點 : 全拉出靜音滑軌, 輕巧的自鎖關閉裝置可自動地使抽屜達到緊閉效果, 防止抽屜意外打開。輕鬆的滑入安裝設計與鎖定設計, 更具易裝易拆的功能。

★ Auto-Return Three Fold Steel Ball Slide

- Length : 300、350、400、450、500 mm
- Install : side install ,interval 13mm
- Load : 35kg/450mm(18")
- Surface : Galvanized-zinc
- Advantage : Full-drawing silent voice slide, Simple self-locked -closed device may be drawing automatic to reach closed effect prevent drawer open by accident. Flexible slide and controlled design had easily installed and dismantled function.

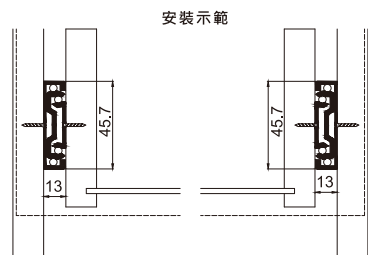

安裝寬度 13mm, 誤差調節+0.2mm
Width 13mm Error Adjustable Flat Screw+0.2mm

I16 塌塌米支撐器

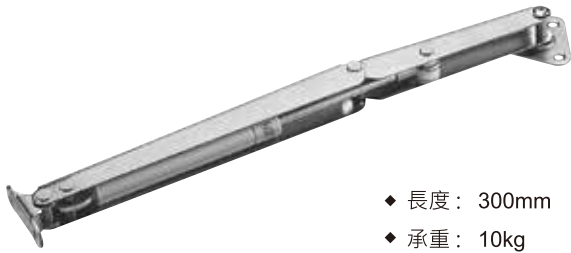

- ◆ 長度：300mm
- ◆ 承重：10kg

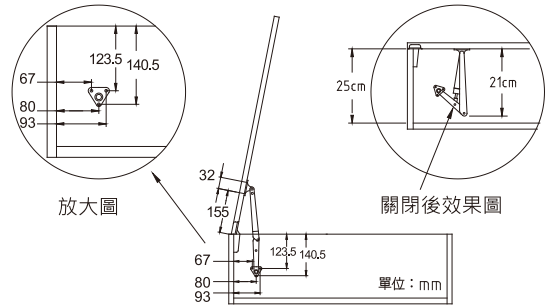

I3051 緩衝合頁撐桿(鏡台鉸鏈)



- ◆ I3051 LWK-輕型(白色) 門板重量不超過3.5公斤
- ◆ I3051 HBK-重型(黑色) 門板重量不超過 5公斤
- ◆ 門板高度不能超過 500mm
- ◆ 門板厚度大於 16mm

I3052 SUSPA 櫃體安全緩衝撐桿

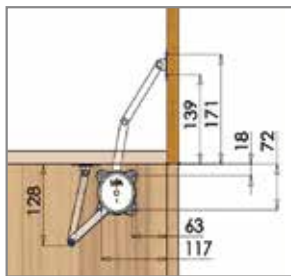

L14WT 活動折合支架



圖示

L14WT10	10"	253*188mm
L14WT12	12"	303*188mm
L14WT14	14"	353*188mm
L14WT18	18"	450*260mm

包裝：2支/組
(適用1000pcs訂製品)

L670 高質感吊衣桿

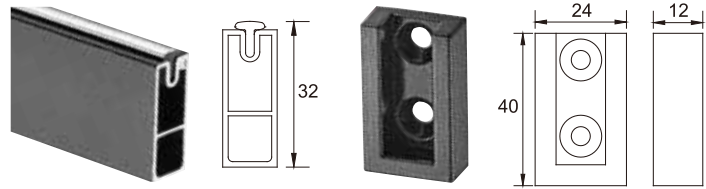

顏色：黑
 尺寸：長度可訂製
 (規格品1米內·訂製品1米以上)

J3051 (黑)鋁出線盒



材質: 鋁合金
 外徑 \varnothing 61mm 內徑 \varnothing 54mm

671 活動式掛鉤(自動彈回)



- ◆ 尺寸：55x24x13mm
- ◆ 顏色：BSN . BK
- ◆ 孔距：16mm

Z627 掛勾



- ◆ 尺寸：W30xH90mm
- ◆ 顏色：SN . BK
- ◆ 孔距：74mm

HD118 鐵板直行輪



材質: 鐵+PVC
 輪直徑 \varnothing 50mm

L668 衣桿固定座

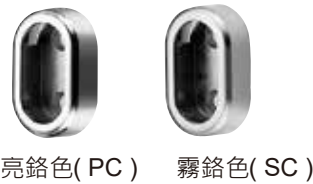

亮銻色(PC) 霧銻色(SC)



示意圖

EC077 鋁合金掛勾

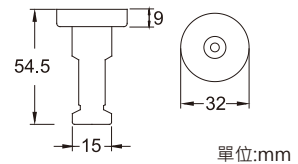

顏色：BK、SC、AB

A057 LED燈(免用變壓器)



燈殼顏色：SC、BK
 正面鎖不用開孔 \varnothing 45mm
 白光(6000K)、自然光(4000K)
 LED 2W 電壓：110-220V共用、H=8mm

TP11P LED電線連結器



規格：5PIN
 尺寸：長2.6cm 寬2.1cm 高1.4cm

TP11A LED觸控迷你開關

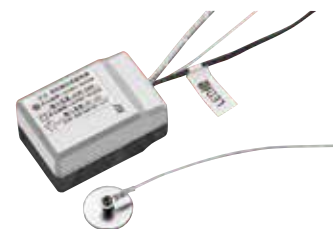

二段式觸碰開關
 60W 110-220V

I-17 塌塌米支撐器



- ◆ 載重：15kg
- ◆ 材質：不銹鋼外殼



L5041 按開式掛衣架

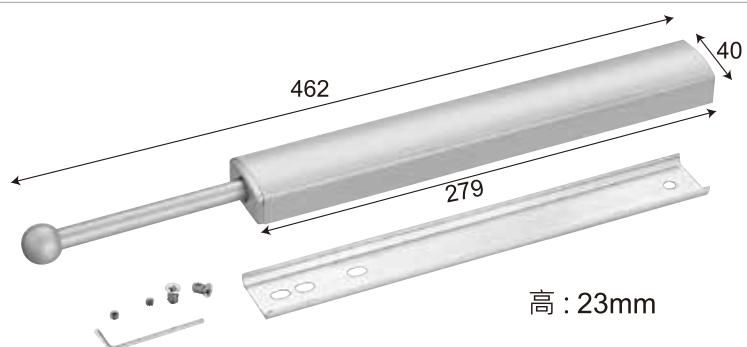

(按開前)



(按開後)

K3511 鋁質套裝折疊凳(隱藏)

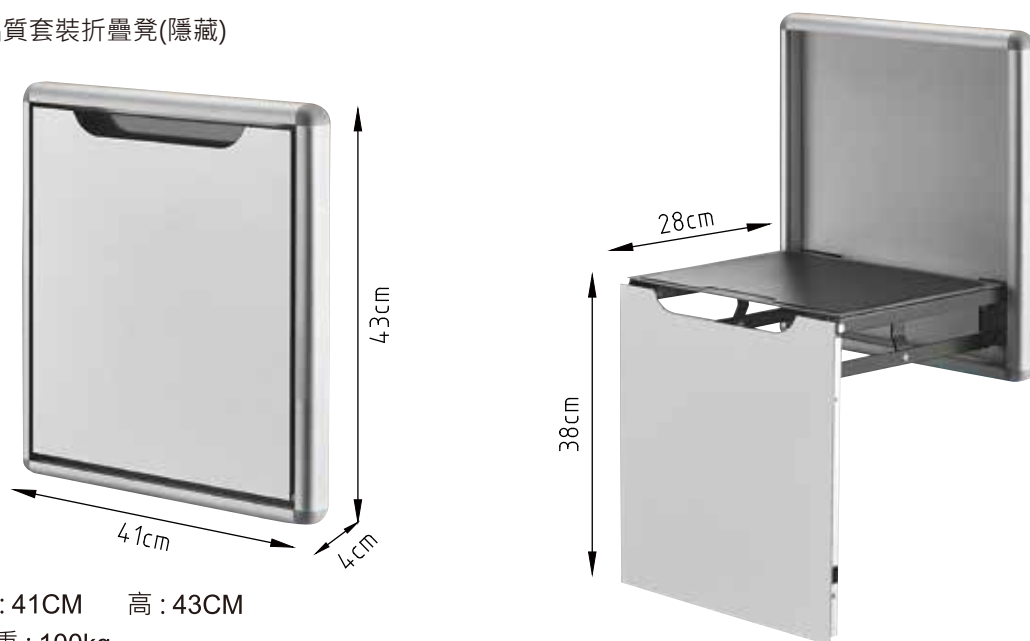

L9081ST 不鏽鋼酒杯架

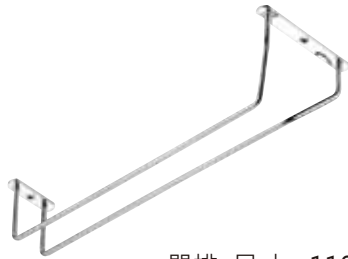

#204

單排 尺寸：110X340mm
雙排 尺寸：215X340mm

L9084ST 不鏽鋼馬克杯架

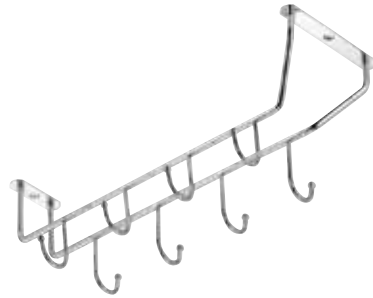

#204

尺寸：105X315mm

669 重型、反彈式拍門器



原始總長 85mm
展開總長 120mm

670 反彈式、拍門器+磁吸



原始總長 80mm
展開總長 120mm

ST496 無痕毛巾桿



吸盤式固定 #304
尺寸：610X45X ϕ 12mm
底座： ϕ 80mm.載重5kg

J3077B 轉盤



尺寸：20.3、30.4、44.2、50.6、60cm

J3079B 玻璃轉盤

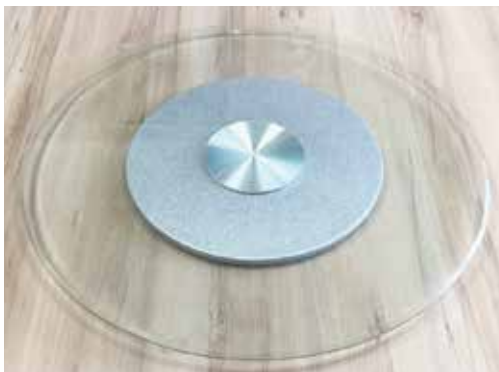

尺寸： ϕ 68cm 強化玻璃厚：8mm 載重：20kg

● 產品特色



玻璃鋼底座，質量輕而堅固



底板為加厚實心鋁合金材質，
拉絲修飾，細膩光滑

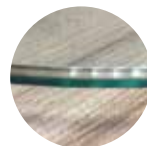

轉面玻璃採用汽車級浮法工藝玻璃，
流質均勻，透明度高，轉面為安全強化玻璃，碎後成鈍面顆粒狀，不傷手

L5004H 緩衝西褲架



L5004H80 76.4X48X7.5cm
L5004H90 86.4X48X7.5cm
(規格：寬x深x高)

L5005H 緩衝飾物架



L5005H80 76.4X48.5X7.5cm
L5005H90 86.4X48.5X7.5cm
(規格：寬x深x高)

L5008H 緩衝頂裝S型褲架



36X45.5X13.5cm
(規格：寬x深x高)

L5037H 緩衝側裝多功能活動西裝褲



40X45.5X22cm
(規格：寬x深x高)

L5009H 緩衝頂裝掛衣架



12X46.7X14cm
(規格：寬x深x高)

L5036H 緩衝頂裝雙排西褲架



65X45.5X13.5cm
(規格：寬x深x高)

L5035H 緩衝多功能西褲架



L5035H80 76.4X47X13.5cm
 L5035H90 86.4X47X13.5cm
 (規格：寬x深x高)

L5039 高櫃旋轉多功能組架(起訂量5組，交期60天)

特色：完全利用衣櫥角落收納
 每一層可360°獨立旋轉
 方便拿衣物，美觀、實用
 安裝簡易、結構穩定
 收納吊掛各式衣物，
 都沒問題唷！



櫃內 76.4X76.4X190~210cm
 (規格：寬x深x高)

L5038 360°三層轉盤



71X71X93.5cm
 (規格：寬x深x高)

AL024-1 鋁框



鋁框顏色：鋁色、黑色



AL024-1 把手邊框

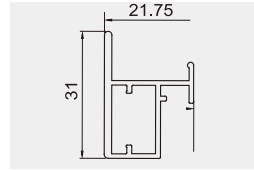

AL024 邊框

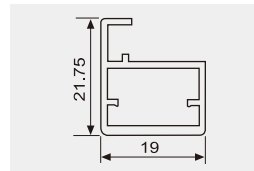

鋁框櫥櫃平移門

AL220 鋁框(無豎框)



鋁框顏色：鋁色、黑色 玻璃板材適用5mm

AL219 鋁框



鋁框顏色：鋁色、黑色 玻璃板材適用5mm

AL219 / AL220 系列配件

豎框

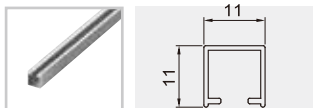

上軌

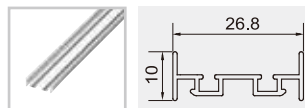

上下框

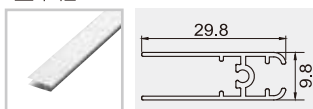

下軌

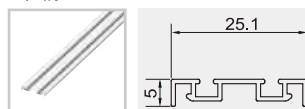

K033 緩衝型上輪



規格：

1. 適用範圍：鋁推拉門專用
2. 適用軌道：內徑35~39mm
3. 最大載重：50kg

K045 單緩衝木門吊輪組



規格：

1. 適用範圍：木門
2. 適用門寬： $\geq 52\text{cm}$
3. 最大載重：50kg

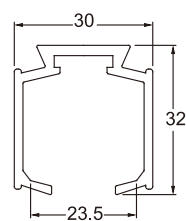

軌道

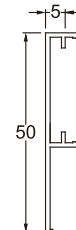

修飾蓋

K046 單緩衝玻璃門吊輪組



規格：

1. 適用範圍：玻璃吊門
2. 適用門厚：8~12mm
3. 適用門寬： $\geq 52\text{cm}$
4. 最大載重：50kg

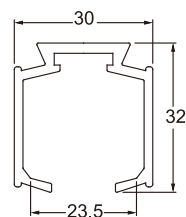

軌道

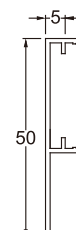

修飾蓋

K043 美式穀倉門



K043P 美式穀倉門緩衝器



◆ 緩衝行程：10cm

◆ 承重：40-60kg



承載重量約90kg左右產品優勢如下：

- 1.可節省空間，穀倉門是牆面推拉式，可節省門片回轉的90度扇形空間。
- 2.造型美觀百搭，美式、簡約、北歐、中式、法式等所有風格，都可以與穀倉門搭配得宜。
- 3.可重複使用，穀倉門一般都會比門洞大，可重複利用性較高。
- 4.軌道長度：2米、2.5米(2種)
- 5.適用板厚：38~45mm
- 6.軌道下緣到天花板至少需要15cm空間才能安裝五金

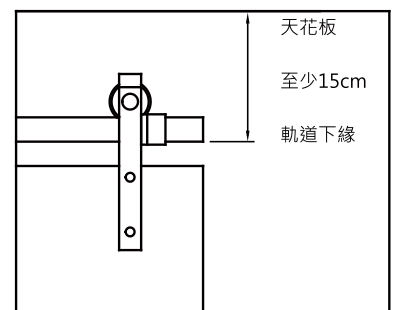

K3508 隱藏摺疊桌配件(五金組合)

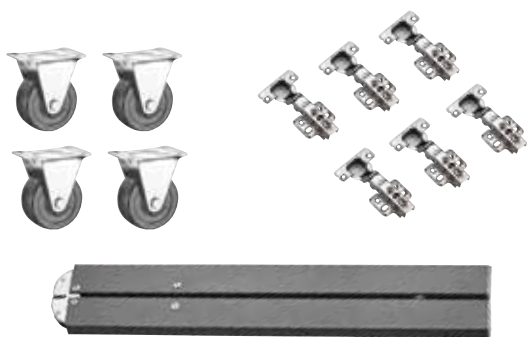

桌面展開承載重量約30kg左右產品優勢如下:

1. 創造空間，提升空間利用率。
2. 操作方便，直接將櫃板把手順勢拉出，便能輕易拉出摺疊桌。
3. 優質五金安裝，使用安全。
4. 隱藏式摺疊桌，為櫥櫃合書房等的實用性設計，提供完美的解決方案。



展開

隱藏

K3507H 隱藏收納桌(五金組合)



7節滑軌每節長度 35cm
 展開長度146.5cm
 載重 50kg



展開

隱藏

K3514 壁掛摺疊桌架(不含層板)

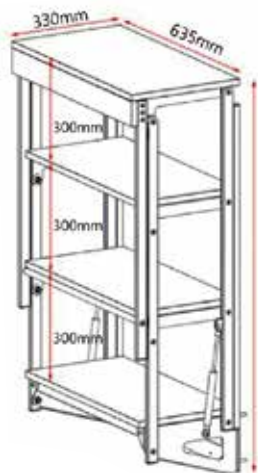

收合



展開

金屬顏色: 黑色
 金屬材質: 鐵質
 最大承重: 50kg

K3512 隱藏下翻式摺疊桌配件

桌面展開承載重量約30kg左右產品優勢如下:

1. 創造空間，提升空間利用率。
2. 操作方便，直接將櫃板把手順勢拉出，便能輕易拉出摺疊桌。
3. 優質五金安裝，使用安全。
4. 隱藏式摺疊桌，為櫥櫃和書房等的實用性設計，提供完美的解決方案



K3513 電動升降桌



最大承重：80kg
 升降架顏色：黑色、鋁色、白色
 升降架材質：鐵質
 輸入電壓：110v~220v

K3510 折疊凳五金

- 1.載重：100kg
- 2.材質：鐵烤漆
- 3.可結合於鞋櫃、牆面等應用貼心的設計。
- 4.方便人們穿鞋時的起坐，清潔地面時凳子更不用搬來搬去，隨時拉出即可當成凳子使用。

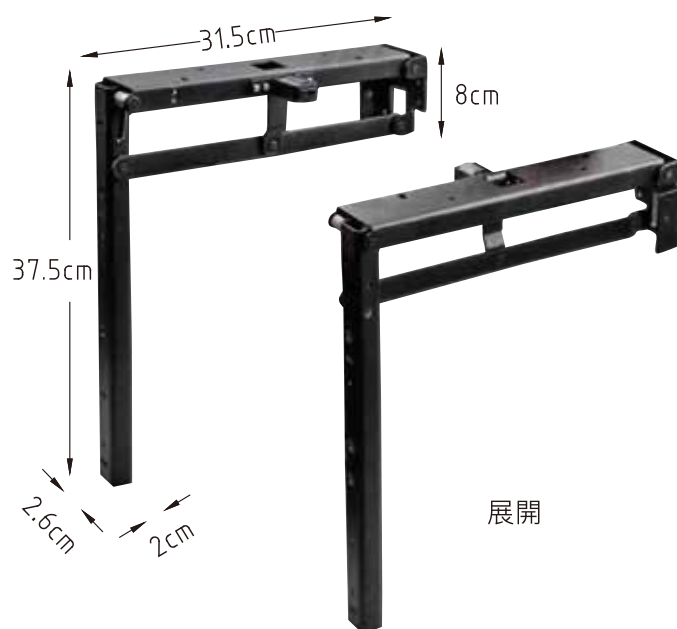

範例一 可結合於鞋櫃家具設計



時尚收納椅
實用
不佔走道空間



範例二 可結合於牆面一體設計

鋁質創作支架

1. 尺寸:長X寬X高·量身訂做·隨意組合
2. 訂購數量不拘
3. 顏色:黑
4. 鋁合金材質支架·不生鏽·結構性佳
5. 鋁管規格: 20X20、25X25、38X38(mm)



愛菲爾竹北店

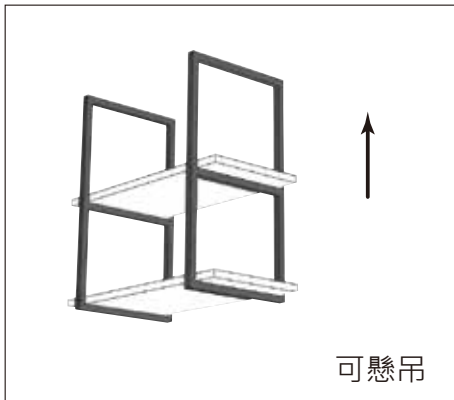

可懸吊

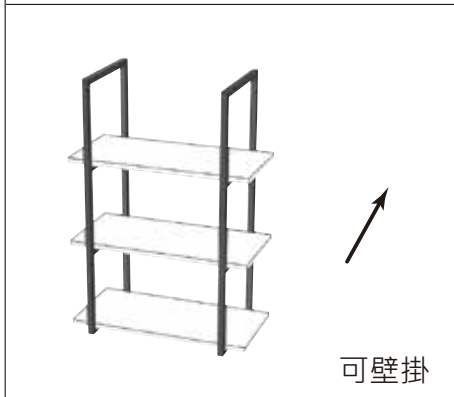

可壁掛



可落地



大也設計



EhShine

鋁框門

ESHINE INDUSTRIAL CO., LTD.

鋁框門專業目錄
—— 歡迎索取







Memo

A series of horizontal lines for writing, consisting of 25 lines spaced evenly down the page.

