



 EhShine

億 誼 五 金



EhShine

 **億 誼 五 金**
EHSHINE INDUSTRIAL CO., LTD.

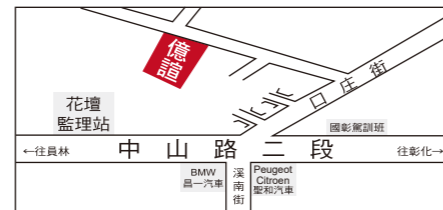
台灣總公司 TAIWAN
彰化縣花壇鄉口庄街101巷16弄61號
TEL: 886-4-7862423 (代表號)
FAX: 886-4-7862224
E-mail: es@hsec.com.tw

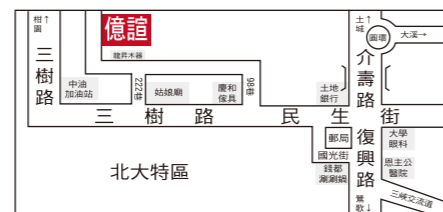

台北展示中心 TAIPEI
新北市三峽區三樹路222巷196之30號
TEL: 886-2-86716300 (代表號)
FAX: 886-2-86716228
E-mail: es.yu@msa.hinet.net



億 誼 五 金
EHSHINE INDUSTRIAL CO., LTD.

When
2023 Only
The Best
Will Do

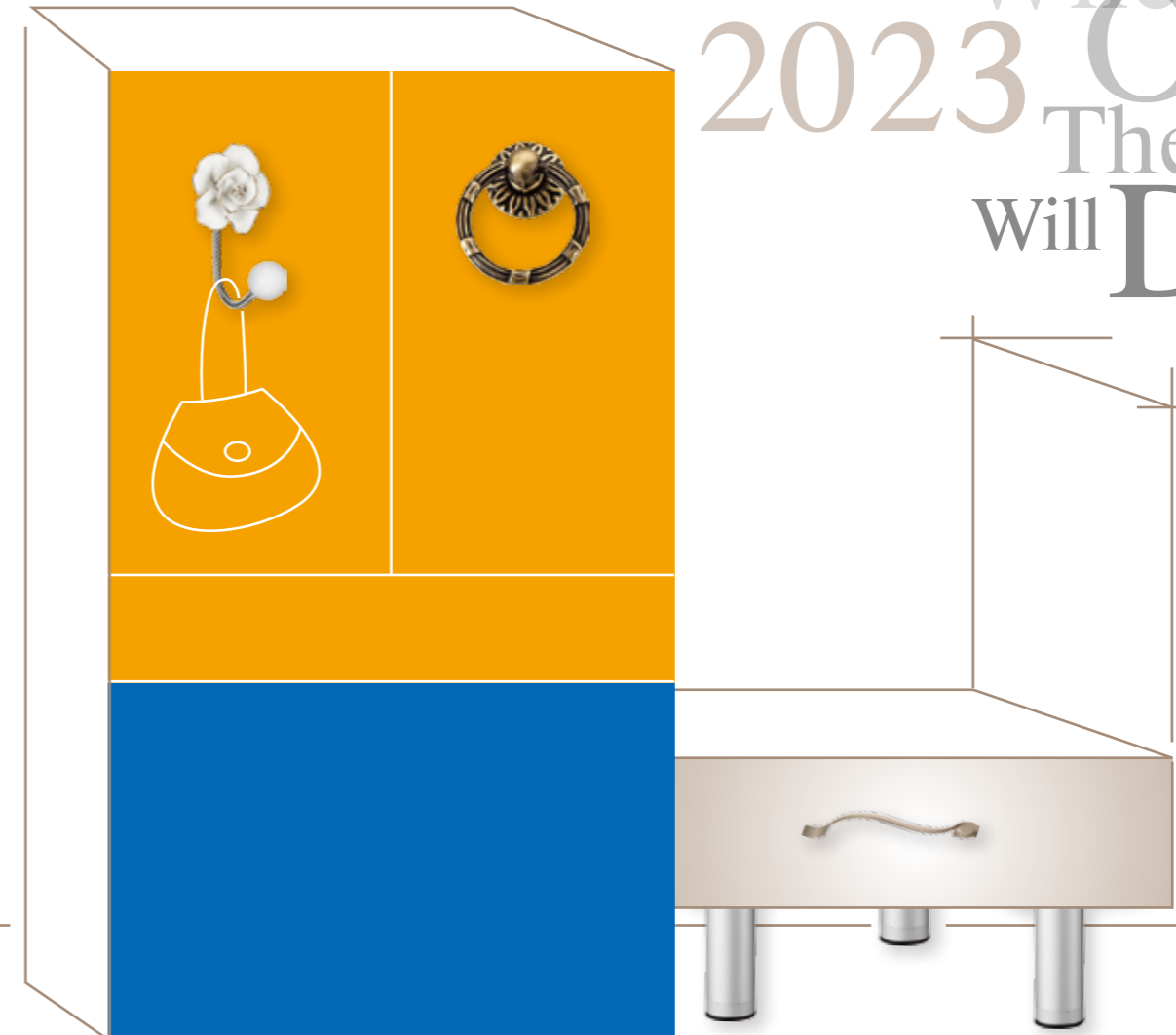

<http://www.ehshine.com.tw>

Index | 產品索引

項目

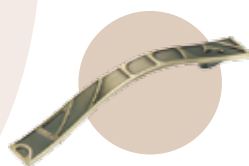

把手系列

現代把手	003~056
古典把手、飾片	057~070
上嵌式把手、封邊把手	071~075



櫥櫃腳系列

櫥櫃腳框	076
餐桌腳	077~078
櫥櫃腳、沙發腳	079~082



配件系列

輪子	083~085
鉸鏈、滑軌	086~093
櫥櫃吊掛、衣勾、酒杯架	094~096
上、下掀油壓撐桿	097~100
櫥櫃配件、壁板支架	100~108
頂天立地組合	109~110
壁板配件組合、地板上掀五金	111~112
新型掀床架、床架五金	113~115
折疊門、側抽門滑軌	116
躺門、推拉門滑輪	117~119
LED燈	120
底板燈、層板燈	121~122
嵌燈及燈類配件	123~124
電視架、櫥櫃配件、CD架	125~126

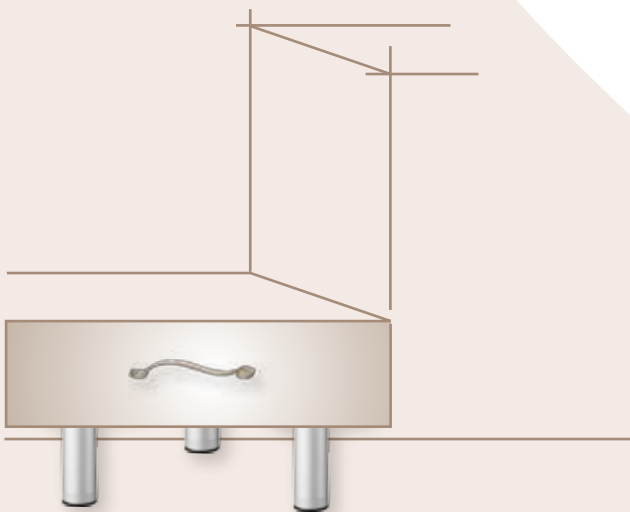

項目



門檔	127~128
門栓、配件	129~131
轉盤、配件	132
鏡珠、墊片及玻璃夾	133~134
拍門器、出線盒、透氣孔	135~136
層板隔板粒、目玉、門止配件	137~138
毛刷條、各式螺絲	139
美式穀倉門五金、緩衝器	140
調整腳、腳釘、羊毛氈	141~142
L鐵片配件	143~144

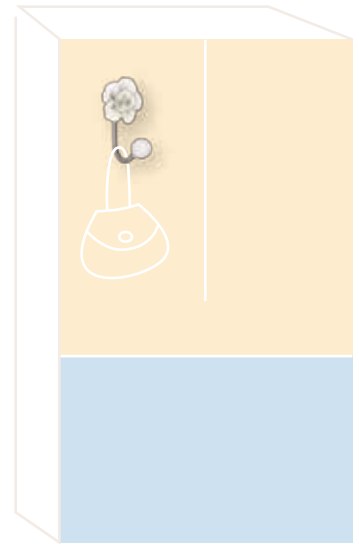

鋁框門系列



鋁框、歐式推拉門完工實例照片	145~146
鋁框移門、吊門	147~154
鋁框櫥櫃門	155~159
鋁封邊條、鋁料圖型對照表	160~162
把手頁碼對照表	163~165

顏色對照表

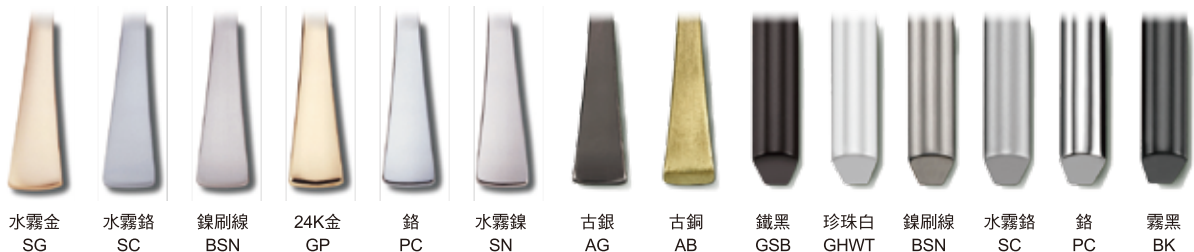

把手材質代號： Z：鋅合金（Zinc） A：鋁合金（Aluminum） E：銅（Brass）
 ST：不鏽鋼（Steeliness） T：木材（Timber） P：塑膠（Plastics）

如何識別編號 5碼如： ZC109 4碼如： A503
材質代號 把手編號 材質代號 把手編號



● 型號：AL029(銀)

▶ 懸吊連動門
極簡就是美的設計案例



● 型號：AL029(黑)

▶▼ 懸吊橫移門

住家也是可以這麼美的，心動了就趕快行動吧！



也可以加裝把手哦！



● 鋁框門 詳細介紹(147~159頁)



Model NO.					
A735-1	180	300	46	32	
	425	600	46	32	

COLOR : CF 皮把手



Model NO.					
A558-1	224	234	31	25	

COLOR : SC



Model NO.					
A735	180	300	46	32	
	425	600	46	32	

COLOR : CF 皮把手(對鎖)



Model NO.					
A558	224	234	31	25	

COLOR : SC 對鎖



Model No.	ϕ	ϕ	ϕ	ϕ	ϕ
Z764	128	167	30		
	256	296	30		

COLOR : PC



Model No.	ϕ	ϕ	ϕ	ϕ	ϕ
Z731	128	164	34	9	
	160	196	34	9	
	256	291	34	9	
	320	355	34	9	

COLOR : BSN - PC



Model No.	ϕ	ϕ	ϕ	ϕ	ϕ
Z765	128	145	32		
	256	273	32		

COLOR : BSN



Model No.	ϕ	ϕ	ϕ	ϕ	ϕ
Z746	128	145	29	30	
	160	180	30	30	
	320	343	27	30	

COLOR : PC



Model No.					
Z760	128	152	26	18	
	224	248	24	19	

COLOR : PC



Model No.					
A766	160/224	256	16	30	
	224/288	320	16	30	

COLOR : PC+SC



Model No.					
A766	160/224	256	16	30	
	224/288	320	16	30	

COLOR : PC+CF



Model No.					
Z732	160	181	30	23	
	224	243	30	23	

COLOR : PC



Model No.					
Z732	32	49x49	25		

COLOR : PC



Model No.				
128/160	200	25	9.5	
192/224	250	25	9.5	
A753	288/320	350	25	9.5
	352/448	500	25	9.5
	576/720	800	25	9.5

COLOR : GSB、BSN 鐵黑色



Model No.				
ZS153	單孔	29x29	23	

COLOR : SB、SC、PC 鐵黑色



Model No.				
AS059	單孔	22	20	

COLOR : GSB、SC、GHWT 鐵黑色



Model No.				
Z725	96	132	25	16
	128	164	25	16

COLOR : SB、PC、SC 鐵黑色



Model No.				
	128	152	25	11
	160	184	25	11
A559	224	248	25	11
	320	344	25	11
	480	542	25	11

COLOR : GSB、SC 鐵黑色



Model No.				
	96	120	28	12
	128	148	28	12
	160	180	28	12
A519	192	212	28	12
	224	245	28	12
	320	340	28	12
	480	500	28	12

COLOR : GSB、SC 鐵黑色

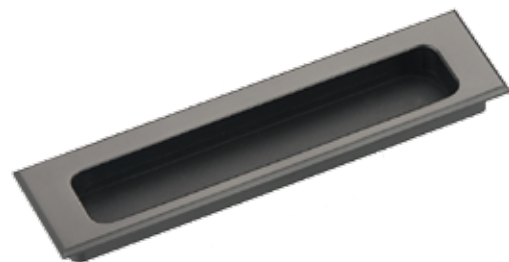

Model No.				
	96	107x29	116x38	10
	128	141x29	150x38	10
A750	160	171x29	180x38	10
	224	235x29	244x38	10
	280	291x29	300x38	10

COLOR : GSB、BSN、SC 鐵黑色



Model No.					
	128	168	26	9.5	
A752	160	200	26	9.5	
	224	250	26	9.5	
	320	350	26	9.5	

COLOR : GSB · BSN · GHWT 鐵黑色



Model No.				
AS063	-S 單孔 19		17	
	-M 單孔 25		21	

COLOR : GSB · SC · GHWT 鐵黑色



Model No.				
AS060	單孔 23		24	

COLOR : GSB · SC 鐵黑色



Model No.				
A599		50	37	
		70	37	
		90	37	

COLOR : GSB · SC 適用6分板 鐵黑色



Model No.				
A590		50	42	
		70	42	
		90	42	
		110	42	
		150	42	

COLOR : GSB · SC · GHWT 鐵黑色



Model No.				
A357		40	17	35
		70	17	35





COLOR : GSB · SC 鐵黑色



Model No.				
A568		50	25	42
		70	25	42
		90	25	42





COLOR : GSB · SC 鐵黑色



Model No.				
A750	96	107x29	116x38	10
	128	141x29	150x38	10

COLOR : GWT、GSB、SC、BSN 亮白



Model No.				
A559	128	152	25	11
	160	184	25	11
	224	248	25	11

COLOR : GHWT、GSB、SC 珍珠白



Model No.				
AS063	S 單孔	19	17	
	M 單孔	25	21	





COLOR : GHWT、GSB、SC 珍珠白



Model No.				
AS059	單孔	22	20	



COLOR : GHWT、GSB、SC 珍珠白



Model No.				
A752	128	168	26	9.5
	160	200	26	9.5
	224	250	26	9.5
	320	350	26	9.5





COLOR : GHWT、BSN、GSB 珍珠白



Model No.				
A753	128/160	200	25	9.5
	192/224	250	25	9.5
	288/320	350	25	9.5





COLOR : GHWT、GSB、BSN 珍珠白



Model No.				
A519	128	148	28	12
	160	180	28	12
	224	245	28	12
	320	340	28	12

COLOR : GHWT、GSB、SC 珍珠白



Model No.				
A590		50	42	
		70	42	
		90	42	
		110	42	
		150	42	

COLOR : GHWT、GSB、SC 珍珠白



Model No.				
A520	64	88	28	12
	96	119	28	12
	128	152	28	12

COLOR : SC



Model No.				
A539	64	73	20	8
	96	106	20	8
	128	139	20	8

COLOR : SC



Model No.				
A521	160	212	28	29
	224	276	28	29
	320	372	28	29
	480	532	28	29

COLOR : SC



Model No.				
A518	160	174	31	32
	224	237	31	32
	320	342	31	32
	480	520	31	32

COLOR : SC



Model No.				
A559	128	152	25	11
	160	184	25	11
	224	248	25	11
	320	344	25	11
	480	542	25	11

COLOR : SC,GSB

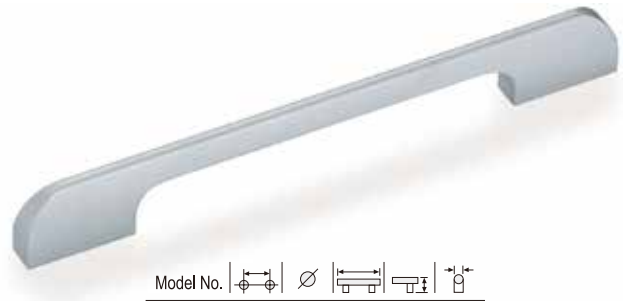

Model No.				
A519	96	120	28	12
	128	148	28	12
	160	180	28	12
	192	212	28	12
	224	245	28	12
	320	340	28	12
	480	500	28	12

COLOR : SC,GSB



Model No.					
Z787	96		112	41	15
COLOR : WBK					



Model No.					
Z787	128		145	43	15
COLOR : WBK					



Model No.					
Z788	96		112	41	15
COLOR : GCK					



Model No.					
Z788	128		145	43	15
COLOR : GCK					



Model No.					
Z789	96		135	28	22
COLOR : WBK					

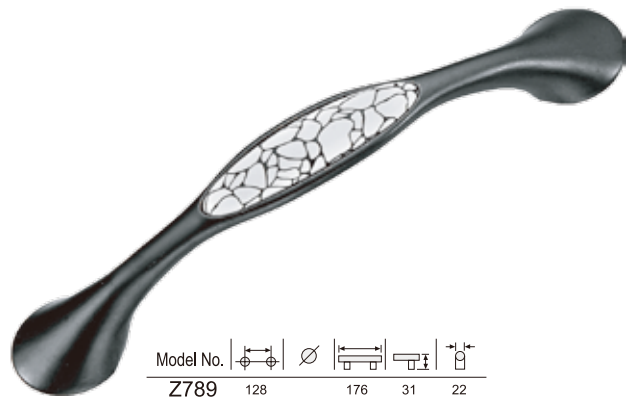

Model No.					
Z789	128		176	31	22
COLOR : WBK					



Model No.					
Z790	96		135	28	22
COLOR : GCK					

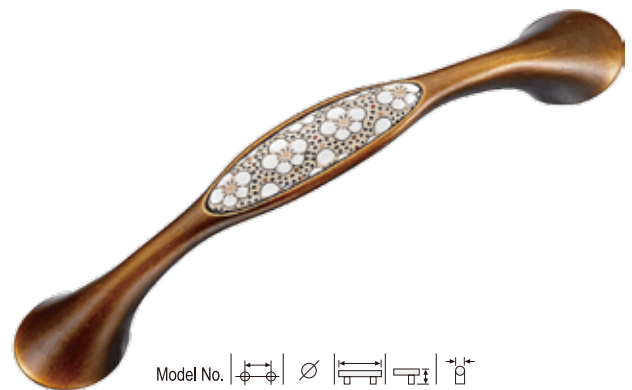

Model No.					
Z790	128		176	31	22
COLOR : GCK					

把手系列一陶瓷、古典把手



Model NO.
 ZS192 單孔 56 28 28
 COLOR : HAB



Model NO.
 Z769 64 84 26 34
 COLOR : HAB



Model NO.
 ZS236 單孔 58 27 29
 COLOR : AB



Model NO.
 Z768 96 135 31 28
 128 178 31 28
 COLOR : HAB



Model NO.
 Z785 96 135 29 28
 COLOR : AB



Model NO.
 Z785 128 167 29 28
 COLOR : AB



Model NO.
 ZS304 單孔 29 26
 COLOR : AB



Model NO.
 Z546 64 80 21 16
 96 118 26 22
 COLOR : AB



Model No.					
Z739	96	115	26	19	
COLOR : AB · PC					



Model No.					
Z738	128	139	30	27	
COLOR : AB · PC					



Model No.					
ZS156	單孔	32	27		
COLOR : PC					



Model No.					
ZS156	單孔	32	27		
COLOR : AB					



Model No.					
Z737	16	58	28	33	
COLOR : AB					



Model No.					
Z754	96	110	38	18	
	128	143	38	20	
COLOR : AB					



Model No.					
Z755	128	139	30	27	
COLOR : AB					



Model No.					
Z806	96	131	25	14	
COLOR : AB					



Model No.					
Z756	16	57	28	33	
COLOR : AB					



Model No.					
Z757	16	57	27	33	
COLOR : AB					



Model No.					
ZS228	單孔	40	33	28	
COLOR : AB					

把手系列—陶瓷把手



Model NO.		\varnothing			
- S 單孔	27		20		
S955-M 單孔	33		24		
- L 單孔	39		28		

COLOR : WT 陶瓷



Model NO.		\varnothing			
S195 單孔	42		38		

COLOR : WT 陶瓷



Model No.		\varnothing			
S430 單孔	36		32		

COLOR : AB 陶瓷



Model No.		\varnothing			
Z597	96		121	37	19
	128		153	37	19

COLOR : AB 陶瓷



Model No.		\varnothing			
S426 單孔	35		32		

COLOR : WT 陶瓷



Model No.		\varnothing			
S431 單孔	35		32		

COLOR : WT 陶瓷



Model No.		\varnothing			
S425 單孔	35		29		

COLOR : WT 陶瓷



Model No.		\varnothing			
S424 單孔	32x32		31		

COLOR : WT 陶瓷



Model No.		\varnothing			
S423 單孔	32x32		31		

COLOR : WT 陶瓷



Model No.		\varnothing			
Z596	96		127	32	19

COLOR : WT 陶瓷

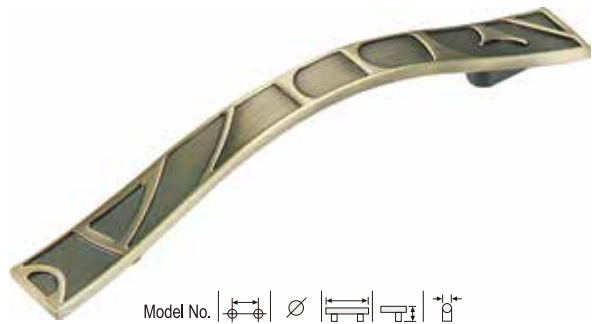

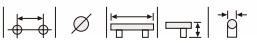
Model No. 
Z702 96 139 24 17
 COLOR : AB · AG



Model No. 
ZS444 單孔 35x35 21
 COLOR : AB · AG



Model No. 
Z706 96 119 24 18
 COLOR : AG · AB · BSN



Model No. 
ZS465 單孔 31x32 21
 COLOR : AG · AB · BSN



Model No. 
Z709 128 150 20 40
 COLOR : AG · AB

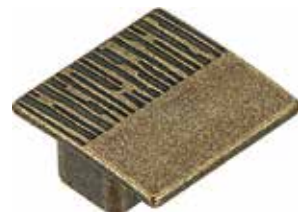

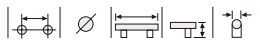
Model No. 
Z709 16 40x40 20
 COLOR : AB · AG



Model No. 
ZS459 單孔 26x24 22
 COLOR : AG

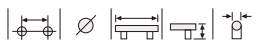

Model No. 
ZS458 單孔 22x22 26
 COLOR : AB · AG



Model NO. 
ZS227 單孔 33 32
 COLOR: **AB**



Model NO. 
ZS227 單孔 33 32
 COLOR: **AG**

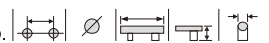

Model NO. 
ZS229 單孔 31x31 25
 COLOR: **AG**

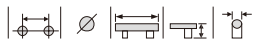

Model NO. 
Z774 96 108 27 17
 128 139 29 17
 COLOR: **AB**



Model NO. 
Z774 96 108 27 17
 128 139 29 17
 COLOR: **AG**



Model NO. 
Z777 96 109 27 22
 128 141 27 21
 COLOR: **AG**



Model NO. 
ZS230 單孔 30 31
 COLOR: **AG**



Model NO. 
ZS231 單孔 31 31
 COLOR: **AG**

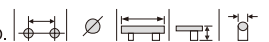

Model NO. 
Z778 96 121 20 17
 128 153 23 19
 COLOR: **AG**



Model No.				
A701	160	224	40	16
	320	380	40	16

COLOR : 咖啡 皮把手



Model No.				
A733	160	226	37	20
	320	380	37	20

COLOR : WT 皮把手

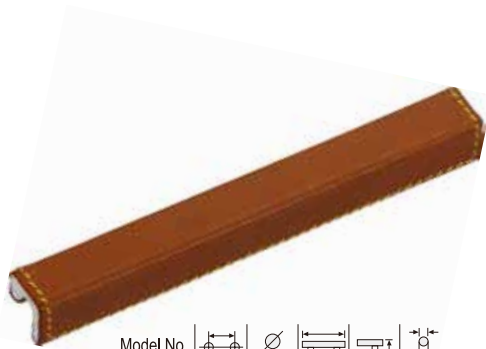

Model No.				
A592-2	32	50	17	18
	96	120	17	18
	128	150	17	18
	160	230	17	18

COLOR : 米黃 皮把手



Model No.				
A592-1	32	50	17	18
	96	120	17	18
	128	150	17	18
	160	230	17	18

COLOR : 咖啡 皮把手



Model No.				
A468	32	54	21	12
	64	94	21	12
	96	123	21	12

COLOR : SC+咖啡皮



Model No.				
Z515	96			
	128			

COLOR : SN+米黃皮 適用500pcs訂製品

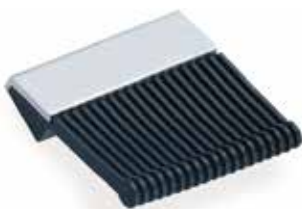

Model No.				
Z510	32	47X45	23	

COLOR : SC+黑色塑膠



Model No.				
Z510	32	47X45	23	

COLOR : PC+深咖啡



Model No.				
Z515	單孔			

COLOR : SN+咖啡皮、SN+米黃 適用500pcs訂製品



Model No.
A589-M 16 70x70 28
 COLOR : 咖啡 皮把手



Model No.
A589-S 16 44x44 25
 COLOR : 咖啡 皮把手



Model No.
AS070 單孔 18 30
 COLOR : SC+咖啡皮



Model No.
AS069 單孔 16 30
 COLOR : SC+咖啡皮



Model No.
ZS 134 單孔 27X25 17
 COLOR : SC+咖啡皮



Model No.
ES136 單孔 48X26 10 20
 COLOR : SC+米黃



Model No.
ZS126 單孔 38X25 18
 COLOR : SC+咖啡皮



Model No.
ZS 149 單孔 39X22 18
 COLOR : SC+深咖啡



Model No.
ZS135 32 37X8 41X13 10 9
 COLOR : PC+咖啡皮、SN+咖啡皮



Model No.
ZS135 32 37X8 41X13 10 9
 COLOR : SN+米黃、PC+米黃



Model No.
ZS124 32 37X9 40.5X12.5 10 9
 COLOR : PC+咖啡皮、SN+咖啡皮



Model No.				
A711	64	80	19	15
	96	112	19	15
	128	144	19	15
	160	176	19	15

COLOR : SC+BK



Model No.				
A713	64	80	24	15
	96	112	24	15
	128	145	24	15
	160	176	24	15

COLOR : SC+BK

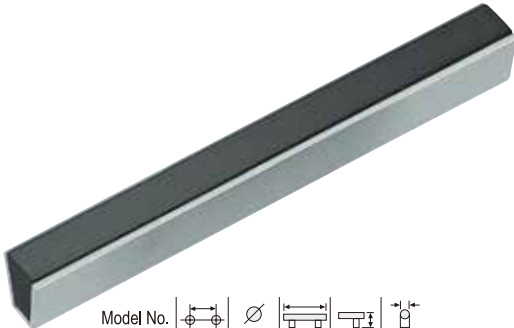

Model No.				
A712	64	80	19	15
	96	112	19	15
	128	144	19	15
	160	176	19	15

COLOR : BK+SC



Model No.				
A714	64	80	24	15
	96	112	24	15
	128	145	24	15
	160	176	24	15

COLOR : BK+SC

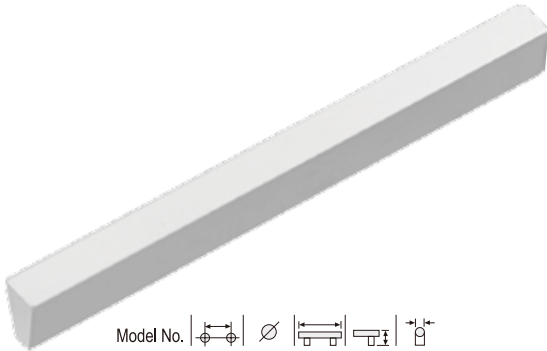

Model No.				
A711-1	64	80	17	11
	96	112	17	11
	128	144	17	11
	160	176	17	11

COLOR : SC

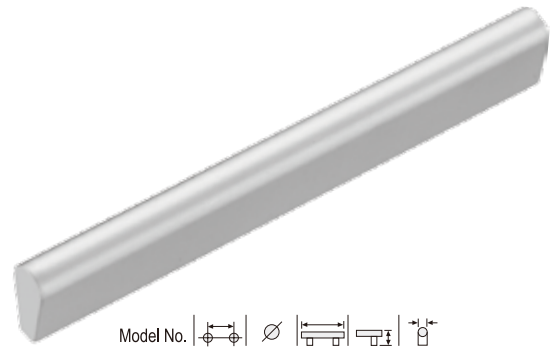

Model No.				
A713-1	64	80	22	11
	96	112	22	11
	128	145	22	11
	160	176	22	11

COLOR : SC



Model No.				
A712-1	64	80	17	11
	96	112	17	11
	128	144	17	11
	160	176	17	11

COLOR : BK



Model No.				
A714-1	64	80	22	11
	96	112	22	11
	128	145	22	11
	160	176	22	11

COLOR : BK



Model No.					
A395	64	130	18	10	
	96	173	18	10	

COLOR : SC+胡桃木



Model No.					
A394	64	130	18	10	
	96	173	18	10	

COLOR : SC



Model No.					
A531	單孔	25	21	11	
	32	50	21	11	
	64	80	21	11	
	96	120	21	11	
	128	160	21	11	
	160	230	21	11	

COLOR : SC+胡桃木



Model No.					
AL007	單孔	25	20	15	
	32	50	20	15	
	64	80	20	15	
	96	120	20	15	
	128	150	20	15	
	160	230	20	15	

COLOR : SC+胡桃木 長度可訂製



Model No.					
A387	單孔	25	20	14	
	32	50	20	14	
	64	80	20	14	
	96	120	20	14	
	128	160	20	14	
	160	230	20	14	

COLOR : SC+胡桃木



Model No.					
A388	單孔	25	21	15	
	32	50	21	15	
	64	80	21	15	
	96	120	21	15	
	128	160	21	15	
	160	230	21	15	

COLOR : SC+胡桃木



Model No.				
A435	32	45	17	9
	64	90	17	9
	96	120	17	9
	128	160	17	9
	160	200	17	9

COLOR : PC+胡桃木



Model No.				
A367-2	32	50	20	14
	64	80	20	14
	96	120	20	14
	128	150	20	14
	160	230	20	14

COLOR : SC+胡桃木



Model No.				
A434	32	45	19	12
	64	90	19	12
	96	120	19	12
	128	160	19	12
	160	200	19	12

COLOR : PC+胡桃木



Model No.				
A367-3	32	50	20	14
	64	80	20	14
	96	120	20	14
	128	150	20	14
	160	230	20	14

COLOR : SC+山毛櫸



Model No.				
A382-1	32	50	21	15
	64	80	21	15
	96	120	21	15
	128	150	21	15
	160	230	21	15

COLOR : SC+胡桃木



Model No.				
A382-2	32	50	21	15
	64	80	21	15
	96	120	21	15
	128	150	21	15
	160	230	21	15

COLOR : SC+山毛櫸



Model No.				
A439	單孔	25	21	15
	64	80	21	15
	96	120	21	15
	128	150	21	15

COLOR : SC+胡桃木



Model No.				
A439	單孔	25	21	15
	64	80	21	15
	96	120	21	15
	128	150	21	15

COLOR : PC+白橡



Model No.				
A542	32	50	17	12
	64	80	17	12
	96	120	17	12
	128	150	17	12
	160	230	17	12

COLOR : PC+SC



Model No.				
A439-1	單孔	25	21	15
	32	50	21	15
	64	80	21	15
	96	120	21	15
	128	150	21	15
	160	230	21	15

COLOR : SC

長度可訂製

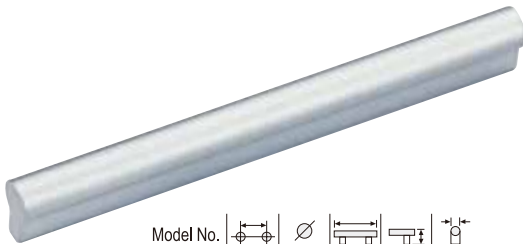

Model No.				
A367	單孔	25	20	12
	32	50	20	12
	64	80	20	12
	96	120	20	12
	128	150	20	12
	160	230	20	12
	224	300	20	12
	320	350	20	12

COLOR : SC

長度可訂製



Model No.				
A382	單孔	25	21	15
	32	50	21	15
	64	80	21	15
	96	120	21	15
	128	150	21	15
	160	230	21	15

COLOR : SC

長度可訂製

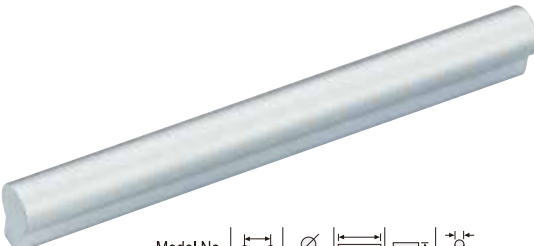

Model No.				
A367-1	單孔	25	20	14
	32	50	20	14
	64	80	20	14
	96	120	20	14
	128	150	20	14
	160	230	20	14
	224	300	20	14
	320	350	20	14

COLOR : SC

長度可訂製



Model No.				
A437	單孔	25	20	15
	32	50	20	15
	64	80	20	15
	96	120	20	15
	128	150	20	15
	160	230	20	15

COLOR : SC

長度可訂製



Model No.				
A400	單孔	25	20	14
	32	50	20	14
	64	80	20	14
	96	120	20	14
	128	150	20	14
	160	230	20	14
320	350	20	14	

COLOR : SC

長度可訂製



Model No.				
A408	單孔	25	21	15
	32	50	21	15
	64	80	21	15
	96	120	21	15
	128	150	21	15
	160	230	21	15

COLOR : SC

長度可訂製



Model No.				
A543	32	50	16	11
	64	80	16	11
	96	120	16	11
	128	150	16	11
	160	230	16	11

COLOR : PC+SC



Model No.				
A432	單孔	25	21	8
	32	50	21	8
	64	80	21	8
	96	120	21	8
	128	150	21	8
	160	230	21	8

COLOR : PC

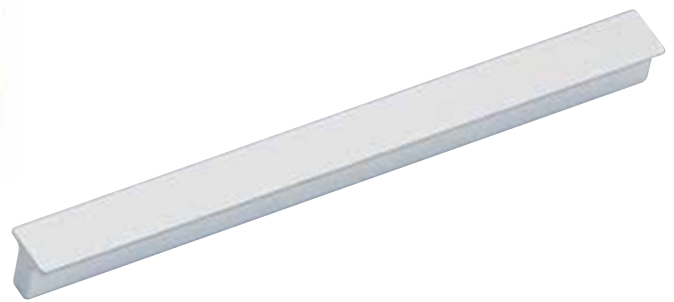

Model No.				
A372	單孔	25	14	14
	32	50	14	14
	64	80	14	14
	96	120	14	14
	128	150	14	14
	160	250	14	14

COLOR : SC

長度可訂製



Model No.				
A432	單孔	25	21	8
	32	50	21	8
	64	80	21	8
	96	120	21	8
	128	150	21	8
	160	230	21	8
	224	300	21	8

COLOR : SC

長度可訂製



Model No.				
A383	單孔	25	16	16
	32	50	16	16
	64	80	16	16
	96	120	16	16
	128	150	16	16
	160	230	16	16

COLOR : SC

長度可訂製



Model No.					
	128	168	26	9.5	
A752	160	200	26	9.5	
	224	250	26	9.5	
	320	350	26	9.5	

COLOR : BSN、GSB、GHWT



Model No.					
A396	32	48	20	25	

COLOR : SC



Model No.					
A396	96	112	20	23	

COLOR : SC



Model No.					
ZS080	單孔	25x25	19		

COLOR : BSN、AB



Model No.					
Z482		109	35	20	

COLOR : BSN、AB



Model No.					
ZS334	單孔	48x48	28		

COLOR : PC、BSN



Model No.					
Z587	96	144	28	49	

COLOR : PC、BSN



Model NO.					
Z786	128	165	27	17	
	160	197	27	17	
	224	275	27	17	

COLOR : PC



Model No.					
Z389	42	48X20	54X24	13	

COLOR : GSC



Model NO.					
Z389	96	101X20	106X24	13	
	128	134X26	149X29	13	

COLOR : GSC - GSB



Model No.					
Z331	-S 單孔	34X9	38X13	10	
	-M 單孔	42X10	52X13	10	

COLOR : BSN - PC



Model No.					
ZCH02	76	86X26	93X32	8	

COLOR : BSN



Model No.					
ST747	93x28	120x40	12		

COLOR : BSN

#202



Model No.					
ZL238	103X22	128X32	10		

COLOR : BSN

(適用推門)



Model No.					
AS061 ^{-S}	35	39	10		
AS061 ^{-M}	42	50	10		

COLOR : SC



Model No.					
Z479	35	40X40	9		

COLOR : SC



Model No.					
ZS130	46X19	50X24	9		

COLOR : GBK、SN



Model No.					
Z505	96	102X28	125X40	10	
	128	135X28	150X40	10	

COLOR : SC



Model No.					
A443	96	106X31	110X33	11	
	128	139X31	143X33	11	
	160	170X31	175X33	11	
	224	235X31	240X33	11	

COLOR : GSC、GBK 長度可訂製



Model No.					
A443	96	106X31	110X33	11	
	128	139X31	143X33	11	
	160	170X31	175X33	11	
	224	235X31	240X33	11	

COLOR : GBK、GSC 長度可訂製



Model No.					
Z474	96	116X37	120X41	10	
	128	148X36	152X41	10	

COLOR : GSC、GSB

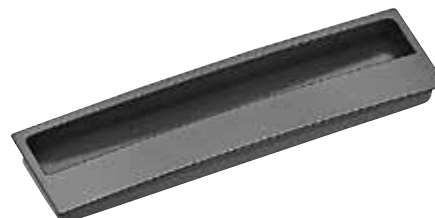

Model No.					
Z474	96	116X37	120X41	10	
	128	148X36	152X41	10	

COLOR : GSB、GSC



Model NO.				
A795	96	112x24	118x30	11
	128	144x24	150x30	11
	160	176x24	182x30	11

COLOR : GSB、SC

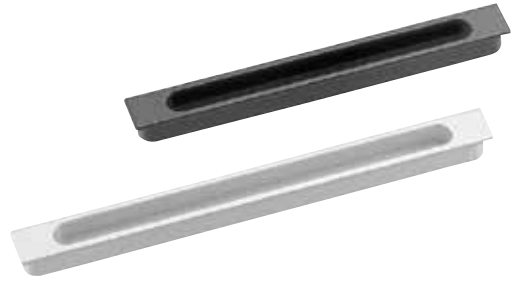

Model NO.				
A796	96	107x12	111x16	11
	128	139x12	143x16	11
	160	171x12	175x16	11

COLOR : GSB、SC (適用推門)



Model No.				
A503	32	53x58	60x62	16

COLOR : SC



Model No.				
A503	96	126x58	134x62	16
	128	151x58	159x62	16

COLOR : SC



Model No.				
ZH914	41x24	45x28	12	

COLOR : SC



Model No.				
ZL231	96	104x31	107x35	12
	128	140x31	143x35	12

COLOR : SC



Model No.				
Z410-S	單孔	46x45	50x50	10

COLOR : SC 適用1000pcs訂製品



Model No.				
Z410-M	64	45x127	50x132	10

COLOR : SC 適用1000pcs訂製品



Model No.	Φ	∅	長	高	厚
A750	96	107x29	116x38	10	
	128	141x29	150x38	10	
	160	171x29	180x38	10	
	224	235x29	244x38	10	
	280	291x29	300x38	10	

COLOR : SC、GSB、BSN



Model No.	Φ	外	內	高	厚
Z703	32	51	42	14	

COLOR : GSC、PC



Model No.	Φ	∅	長	高	厚
Z419	35	41	8		

COLOR : SN



Model No.	Φ	∅	長	高	厚
A580	無孔		13	54	

COLOR : SC+PC 適用6分板·長度可訂製



Model No.	Φ	∅	長	高	厚
A572	96	92x41	103x44	14	
	128	124x41	135x44	14	
	160	156x41	167x44	14	
	192	188x41	199x44	14	
	224	220x41	231x44	14	

COLOR : SC 長度可訂製



Model No.	Φ	∅	長	高	厚
Z724	96	107x30	122x39	14	
	128	139x30	153x39	14	

COLOR : PC、AB



Model No.	Φ	∅	長	高	厚
A571	106x36		116x42	16	
	138x36		148x42	16	
	170x36		180x42	16	
	234x36		244x42	16	

COLOR : SC 長度可訂製



Model No.					
A453	128		197	24	20

COLOR : PC



Model No.					
A453	128		197	24	20

COLOR : SC



Model No.					
Z495	128		167	24	11

COLOR : SC



Model No.					
Z76	160		220	29	26

COLOR : SC



Model No.					
A523	128		146	33	18
	160		179	33	18
	224		242	33	18

COLOR : SC



Model No.					
A512	128		149	30	25
	160		188	30	25
	224		251	30	25
	320		358	30	25

COLOR : SC



Model No.					
A534	128		155	32	23
	160		186	32	23
	224		261	32	23
	320		385	32	23

COLOR : SC



Model No.					
A513	160		230	32	25

COLOR : SC 適用500pcs訂製品

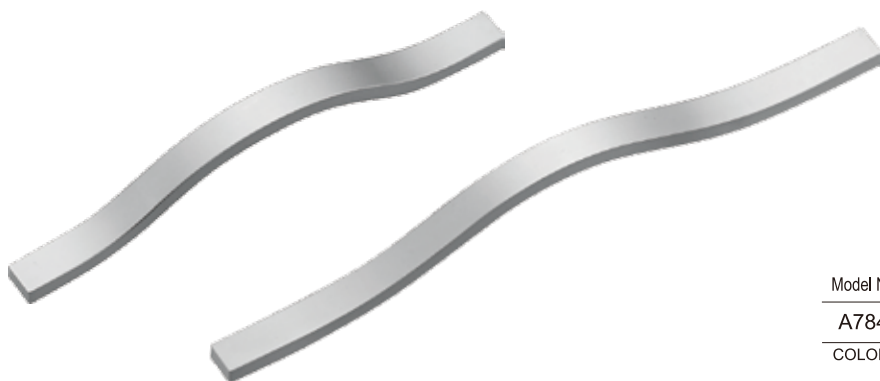

Model No.					
A784	192	205	28	12	
	256	270	29	12	

COLOR : SC



Model No.					
A550	128	133	28	12	
	160	165	28	12	
	224	229	28	12	
	320	326	28	12	

COLOR : SC



Model No.					
A450	96	102	31	21	
	128	134	31	21	
	160	165	31	21	
	224	229	31	21	
	320	328	31	21	
	600	607	31	21	

COLOR : SC



Model No.					
A524	128	133	29	20	
	160	167	29	20	
	224	228	29	20	
	320	327	29	20	

COLOR : SC



Model No.					
A380	96	106	33	14	
	128	138	33	14	
	224	234	33	14	
	320	330	33	14	

COLOR : SC



Model No.					
A398	64	74	35	13	
	96	106	35	13	
	128	138	35	13	
	160	170	35	13	
	224	234	35	13	
	320	330	35	13	
	600	610	35	13	

COLOR : SC+PC 長度可訂製



Model No.					
A433	96	112	36	14	
	128	144	36	14	
	160	176	36	14	
	224	240	36	14	
	320	336	36	14	

COLOR : SC 長度可訂製



Model No.				
Z563	96	110	34	14
	128	144	34	14

COLOR : BSN、PC、SC



Model No.				
Z491	128/160	167	27	
	192/224	230	27	

COLOR : SC



Model No.				
Z540	96/128	150	23	15
	160/192	211	23	15

COLOR : SC



Model No.				
ST486	96	150	28	10
	128	170	28	10
	210	250	28	10
	310	350	28	10
	510	550	28	10

COLOR : BSN #202 空心管



Model No.				
ST467	96	150	32	12
	128	182	32	12
	160	224	32	12
	224	288	32	12
	320	355	32	12

COLOR : BSN #202 實心管



Model No.				
ST492	128	177	35	14
	210	250	35	14
	310	350	35	14
	510	550	35	14
	704	850	35	14

COLOR : BSN #202 空心管



Model No.				
A411	96	150	34	11
	210	250	34	11
	310	350	34	11
	510	550	34	11

COLOR : SC 鋁合金實心管

把手系列—現代把手

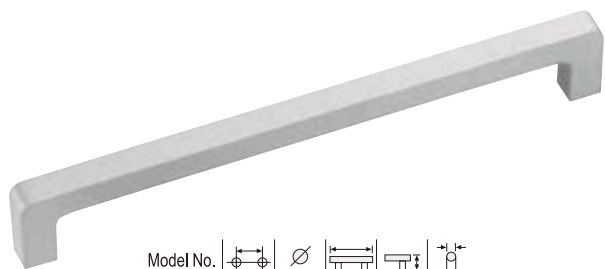

Model No.				
A776	128	138	25	9.5
	160	170	25	9.5
	224	234	25	9.5
	320	330	25	9.5

COLOR : SC

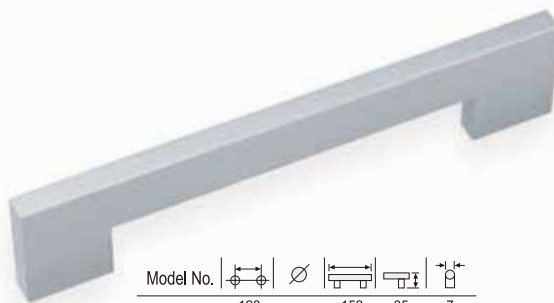

Model No.				
A574	128	152	35	7
	160	184	35	7
	224	250	35	7
	320	362	35	7
	480	530	35	7

COLOR : SC



Model No.				
A715	96	150	27	6
	128	182	27	6
	160	214	27	6
	256	310	27	6
	320	374	27	6

COLOR : SC



Model No.				
A412	96	111	32	16
	128	143	32	16
	160	175	32	16
	224	239	32	16
	320	335	32	16
	510	525	32	16

COLOR : SC 長度可訂製

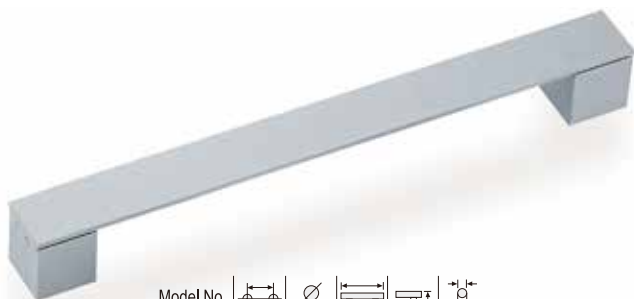

Model No.				
A553	128	153	31	25
	160	185	31	25
	224	249	31	25
	320	345	31	25
	510	535	31	25

COLOR : SC 長度可訂製



Model No.				
A442	128	142	32	16
	160	174	32	16
	224	239	32	16
	320	335	32	16
	510	525	32	16

COLOR : SC 長度可訂製

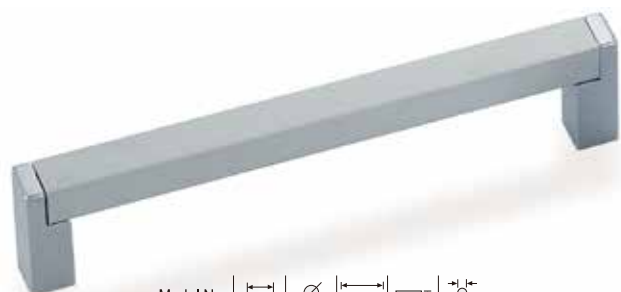

Model No.				
A530	96	109	38	13
	128	141	38	13
	160	173	38	13
	224	237	38	13
	320	334	38	13

COLOR : SC 長度可訂製



Model No.				
Z35	192	224	22	19.5

COLOR : SC



Model No.					
Z544	128	190	30	14	
	160	220	36	19	

COLOR : BSN



Model No.					
Z508	128	148	26	10	
	160	179	26	10	

COLOR : PC+SC



Model No.					
A525	128	145	28	9	
	160	177	28	9	

COLOR : PC+SC



Model No.					
Z526	96	125	21	16	
	128	160	21	16	

COLOR : BSN



Model No.					
Z506	128	146	22	15	
	192	210	25	18	

COLOR : SC



Model No.					
Z472	64	113	19	12	
	128/160	232	24	15	

COLOR : SC



Model No.					
Z591	160	169	27	22	
	224	233	27	22	

COLOR : BSN、PC



Model No.					
Z717	160	26	169	26	18
	320		338	26	18

COLOR : PC



Model No.					
Z717	64		74	26	18

COLOR : PC



Model No.					
A716	96		136	31	20
	128		168	31	20
	160		199	31	20

COLOR : SC+BK



Model No.					
Z720	160		194	26	27

COLOR : SC、PC
中空型把手
可透視門板顏色



Model No.					
Z719	160		194	26	27

COLOR : SC、PC
可自行貼皮
可夾厚度3mm以下



Model No.					
Z719	160		194	26	27

COLOR : SC+胡桃、SC+白橡
PC+胡桃、PC+白橡



Model No.					
Z719	160		194	26	27

COLOR : SC+白橡、SC+胡桃
PC+白橡、PC+胡桃



Model No.					
Z338	96	150	23	10	

COLOR : SN+綠、PC+GP



Model No.				
A381	25	32	15	

COLOR : SC



Model No.					
Z402	128	138	30	13	

COLOR : SC+胡桃木



Model No.					
Z375	96	122	23	5	

COLOR : PC 適用500pcs訂製品



Model No.					
Z350	96	110	24	16	

COLOR : 依需求 適用500pcs訂製品



Model No.					
Z339	64	78	36	7	
	96	110	36	7	

COLOR : SN、SC、PC 適用500pcs訂製品



Model No.					
A537	96	120	19	50	
	128	150	19	50	
	224	250	19	50	
	320	350	19	50	

COLOR : SC



Model No.					
Z369	96		136	20	16
	128		182	24	22

COLOR : BSN、SC、PC、SN



Model No.					
Z226	128		150	25	13

COLOR : SN、BSN



Model No.					
Z314	64		80	23	6
	96		113	28	6
	128		162	29	6

COLOR : BSN、SC、PC、SN



Model No.					
Z345	96		125	27	17
	128		157	27	17

COLOR : SC、PC、SN



Model No.					
Z360	128		160	30	

COLOR : SN、SC、PC



Model No.					
Z374	96		108	30	15
	128		145	30	15

COLOR : SN、SC、PC、BSN



Model No.					
Z82	96		126	23	13
	128		158	30	18

COLOR : GSC



Model No.				
Z464	32	46X40	8	

COLOR : SC



Model No.					
Z541	32	40	20	33	

COLOR : SC



Model No.				
A504	96	120	19	40
	128	150	19	40
	160	190	19	40
	192	250	19	40

COLOR : SC



Model No.					
Z541	96	120	20	33	

COLOR : SC



Model No.				
A416	16	30	20	30
	32	50	20	30
	64	80	20	30
	96	120	20	30
	128	150	20	30

COLOR : SC 長度可訂製



Model No.				
A570	64	78	15	27
	96	116	15	27
	128	148	15	27
	160	180	15	27
	224	244	15	27

COLOR : SC 長度可訂製



Model No.				
A536	32	50	13	53
	96	120	13	53
	128	150	13	53
	224	300	13	53
	320	400	13	53

COLOR : SC



Model No.				
A567			56	25
A567-1			40	25

COLOR : SC、GBK 長度可訂製



把手固定座



Model No.
Z464 64 72X30 8
 COLOR : PC



Model No.
Z469 96 125 23 13
 COLOR : PC



Model No.
Z466 32 42X37 6
 COLOR : PC、SC



Model No.
Z413-S 32 40X40 8
 COLOR : GSC



Model No.
Z415 55 81 5 38
 COLOR : SC (正面鎖)



Model No.
Z417 64 72 8
 COLOR : SC



Model No.
Z463 32 40 20
 COLOR : SC



Model No.
Z352 32 78 29
 COLOR : GP、PC、SN、GBK



Model No.
Z343-1 單孔 50 18
 COLOR : PC







Model No.
ZL94 32 50 26
 COLOR : SN







del. No.
Z371 32 50 19
 COLOR : BSN、BK 適用外銷單



Model No.				
	160	172	35	23
Z700	320	340	35	23
	480	497	35	23





COLOR : BSN



Model No.				
Z344	96	140	26	11
	128	186	34	13





COLOR : PC、SC、SN、BSN



Model No.				
Z321	96	130	25	





COLOR : BSN、PC、SN



Model No.				
Z311	64	78	22	7
	96	112	22	7





COLOR : PC 適用500pcs訂製品



Model No.				
Z351	64	95	22	
	96	135	27	





COLOR : PC、SC、SN、GP



Model No.				
Z332	96	112	25	
	128	145	25	

COLOR : PC 適用500pcs訂製品



Model No.				
ZCH01	96	109	22	17

COLOR : SN



Model No.					
Z704	64	149	22	11	
	96	199	22	11	

COLOR : PC、BSN



Model No.					
Z718	160	181	23	11	
	320	340	23	11	

COLOR : PC



Model No.					
Z201	96	142	22	9	

COLOR : PC、SN



Model No.					
Z487	224	265	25	20	

COLOR : PC+塑膠



Model No.					
Z47	96	132	27	15	

COLOR : GSC



Model No.					
A453	128	197	24	20	

COLOR : SC、PC



Model No.					
Z475	128	134	30	7	

COLOR : SC



Model No.					
E206	31	39	32		
	64	72	32		

COLOR : PC、BSN、SC、PC (31)

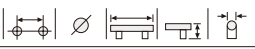

Model No. 

ZS153	單孔	29x29	23
-------	----	-------	----

COLOR : SC · SB · PC



Model No. 

Z725	96	132	25	16
	128	164	25	16

COLOR : SC · SB · PC

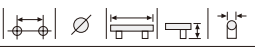

Model No. 

ZS154	單孔	28x28	20
-------	----	-------	----

COLOR : PC



Model No. 

Z726	96	104	22	21
	128	136	22	21

COLOR : PC

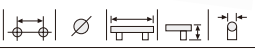

Model No. 

Z728	32	49	30	36
	96	114	30	36
	160	178	30	36

COLOR : AG · AB

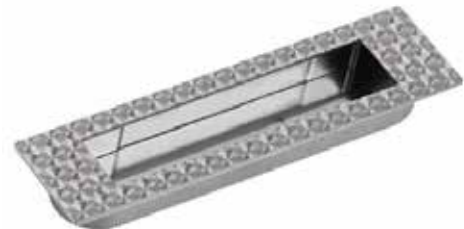

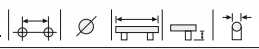
Model No. 

Z722	96	107x30	122x39	14
	128	139x30	153x39	14

COLOR : SC · AB

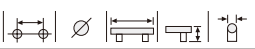

Model No. 

Z730	96	109	29	11
	192	204	29	11

COLOR : PC

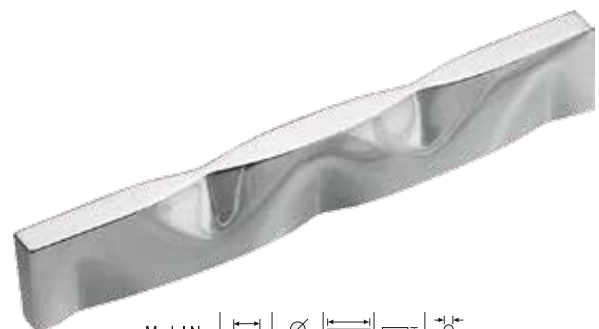

Model No. 

Z730	160	172	29	11
------	-----	-----	----	----

COLOR : PC



Model No.					
ZS188	單孔	41			22
COLOR : PC					

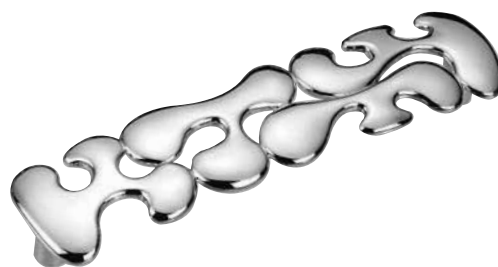

Model No.					
Z762	128		145	24	35
COLOR : PC					



Model No.					
Z741	64		75	25	39
COLOR : PC、BSN					



Model No.					
Z742	64		112	25	34
	96		169	25	51
COLOR : PC、BSN					



Model No.					
Z727	128		148	25	40
COLOR : BSN					



Model No.					
Z727	96		110	18	30
	128		148	25	40
COLOR : PC					



Model No.					
Z743	128	194	21	48	
	160	226	23	48	
COLOR : PC、BSN					



Model No.					
Z761	96	144	19	37	
	160	206	19	37	
COLOR : PC					



Model No.					
Z641	28		3		

COLOR : BSN · SC (正面鎖底座)



Model No.					
Z780	128	156	30	28	
	160	187	30	28	

COLOR : SC (正面鎖)



Model No.					
A781	96	150	37	28	
	210	250	37	28	
	310	350	37	28	
	510	550	37	28	

COLOR : SC (正面鎖)



Model No.					
Z779	96	140	28	28	
	128	186	38	28	

COLOR : BSN · SC (正面鎖)



Model No.					
Z527 ^{-M}		128	22	10	
Z527 ^{-L}		153	29	12	

COLOR : SC (正面鎖)



Model No.					
A599		50	37		
		70	37		
		90	37		

COLOR : SC 適用6分板 · 長度可訂製



Model No.					
A590		50	42		
		70	42		
		90	42		
		110	42		
		150	42		

COLOR : SC 長度可訂製



Model No.					
A357		40	17	35	
		70	17	35	

COLOR : SC 長度可訂製



Model No.					
A568		50	25	42	
		70	25	42	
		90	25	42	

COLOR : SC 長度可訂製

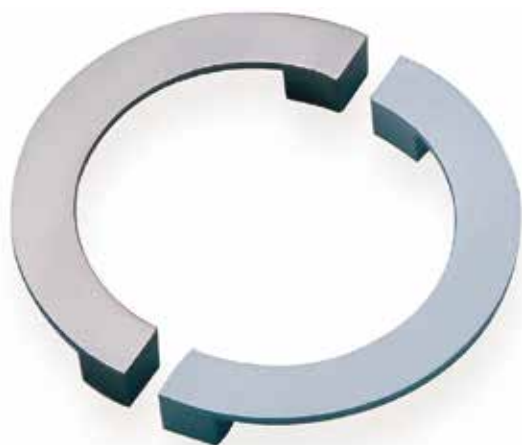

Model No.					
Z440	96	114	19	20	
	128	146	19	20	

COLOR : SC · BSN



Model No.				
Z710	32	52	17	

COLOR : GSC · PC · BSN



Model No.				
A705	32	78	38	

COLOR : PC

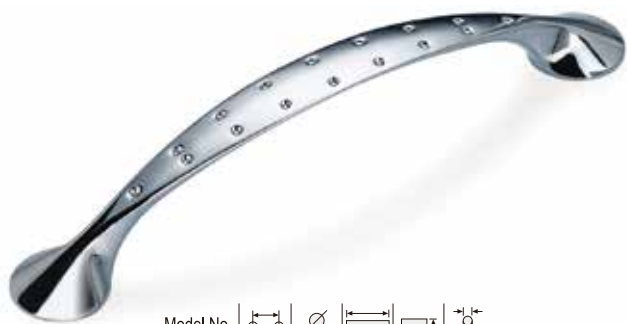

Model No.					
Z535	128	166	30	15	

COLOR : PC



Model No.					
Z348	128	165	29	20	

COLOR : BSN · SN



Model No.					
ZL31	96	154	27	30	
	128	190	27	30	

COLOR : BSN



Model No.					
ZL26	128	146	26	19	
	160	178	26	19	

COLOR : SC · BSN (160)

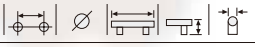

Model No. 
ZS083 單孔 25 13 25
 COLOR : SC



Model No. 
ZH912 單孔 15 22
 COLOR : SC



Model No. 
ZH911 單孔 22 20
 COLOR : SC



Model No. 
ZS077 單孔 26 23
 COLOR : SC



Model No. 
AS084 單孔 19 25
 COLOR : SC



Model No. 
AS324^S 單孔 15 18
^M 單孔 20 22
 COLOR : SC



Model No. 
ZS093 單孔 34 23 26
 COLOR : SC



Model No. 
ZS003 單孔 12 23
 單孔 15 23
 COLOR : SC、PC、SN、BSN



Model No. 
AS003 單孔 20 25
 單孔 25 25
 COLOR : SC



Model No. 
ES014 單孔 18 22
 COLOR : PC、BSN、SN



Model No. 
ZS039 單孔 25 26
 COLOR : BSN

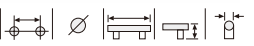

Model No. 
ZS030 單孔 40X12 23
 COLOR : SN、PC



Model No. 
AS058 單孔 12 20
 COLOR : SC



Model No. 
AS302 單孔 15 19
 COLOR : SC



Model No. 
AS301 單孔 14 21
 COLOR : SC



Model No. 
AS063 ^S 單孔 19 17
_M 單孔 25 21
 COLOR : SC、GSB、GHWT



Model No. 
AS059 單孔 22 20
 COLOR : SC、GSB、GHWT



Model No. 
AS060 單孔 23 24
 COLOR : SC、GSB



Model No. 
ZS096 單孔 30 23
 COLOR : SC



Model No. 
ZS097 單孔 40 21
 COLOR : PC



Model No. 
ZS097 單孔 40 21
 COLOR : SC

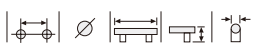

Model No. 
ZS076 單孔 34 24
 COLOR : SC



Model No. 
ZS092 單孔 30 26 30
 COLOR : SC 適用1,000 訂製品

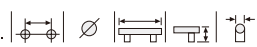

Model No. 
ZS095 單孔 32 22 32
 COLOR : BSN



Model No. 
ZS075 單孔 21X21 25
 COLOR : BSN

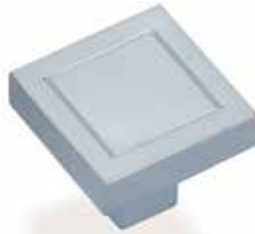

Model No. 
ZS055 -S 單孔 18X18 20 18
 -M 單孔 24X24 21 24
 COLOR : SC



Model No. 
ZS080 單孔 25X25 19
 COLOR : BSN、AB



Model No. 
ZS078-S 單孔 28X28 18
 COLOR : PC、AB、SC

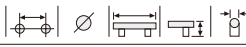

Model No. 
ZS078-M 單孔 40X40 20
 COLOR : SC、AB、PC

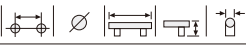

Model No. 
ZS087 -S 單孔 30X30 19
 -M 單孔 50X50 20
 COLOR : SC



Model No. 
ZS081 單孔 40X20 19
 COLOR : BSN、AB



Model No. 
ZS057 單孔 20X45 16
 COLOR : PC、BSN、SC、SN



Model No. 
ZS045 -S 單孔 18X18 21
 -M 單孔 24X24 23
 COLOR : SC、AB

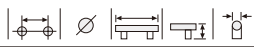

Model No. 
ZCH06 單孔 38X15 20
 COLOR : SN



Model No. 
ZCH07 單孔 32X12 23
 COLOR : SN

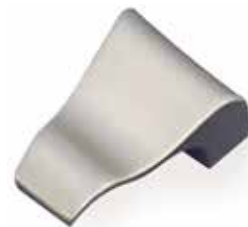

Model No. 
ZCH04 11 40X20 23
 16 40X20 23
 COLOR : SN



Model No.
ZS125 單孔 36X15 12
 COLOR : SN、PC、SC



Model No.
ZS128 單孔 38X25 17
 COLOR : SC、PC



Model No.
ZS129 單孔 42X14 15
 COLOR : PC、SC



Model No.
ZS138 單孔 66X19 17
 COLOR : PC



Model No.
ES119 單孔 40X25 24
 COLOR : PC、GP、SG



Model No.
ZS142 單孔 45X15 21
 COLOR : PC、SN



Model No.
ZS137-S 單孔 33X25 9
 COLOR : PC、AB、SC



Model No.
ZS137-M 單孔 46X25 9
 COLOR : SC、AB、PC



Model No.
ZS148 ^{-S} 單孔 35X25 11 35
^{-M} 單孔 49X35 16 49
 COLOR : SC



Model No.
ZS088-S 單孔 46X42 12
 COLOR : PC、SC、SN



Model No.
ZS089 單孔 47X42 11
 COLOR : SN、SC



Model No.
ZS144 單孔 46X43 15
 COLOR : SN、PC



Model No. 

ZS022-S	單孔	28	24
ZS022-M	單孔	33	27

COLOR : SN、SC、PC



Model No. 

ZS025	單孔	32	25
-------	----	----	----

COLOR : SC、SN



Model No. 

ES012	單孔	15	19
	單孔	18	23

COLOR : PC、SN、SC



Model No. 

ES106	單孔	17	26
-------	----	----	----

COLOR : NB+GP、SN+GP



Model No. 

ZS002-S	單孔	25X15	26
---------	----	-------	----

COLOR : PC、SN、BSN



Model No. 

ES026-M	單孔	22	25
---------	----	----	----

COLOR : SN、SG、GP、GBK



Model No. 

ZS908	單孔	23X14	28
-------	----	-------	----

COLOR : SN



Model No. 

ZS001	單孔	35X19	23
-------	----	-------	----

COLOR : PC、BSN、SN



Model No. 

ZCH05	單孔	42X16	23
-------	----	-------	----

COLOR : SN



Model No. 

ZS027	單孔	32X18	31
-------	----	-------	----

COLOR : SN、PC、SG、GP



Model No. 

ZS120	單孔	36X20	10
-------	----	-------	----

COLOR : GSC



Model No. 

ZS051	單孔	20X5	18
-------	----	------	----

COLOR : GSN、GSC



Model No. 
AS132 單孔 23 23
 COLOR : SC+胡桃木



Model No. 
AS059 單孔 22 20
 COLOR : SC、GSB、GHWT



Model No. 
AS060 單孔 23 24
 COLOR : SC、GSB



Model No. 
AS324 -S 單孔 15 18
 -M 單孔 20 22
 COLOR : SC

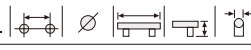

Model No. 
ZS032 單孔 38X37 25
 COLOR : SC、SN

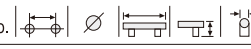

Model No. 
AS333 單孔 15 16
 COLOR : PC



Model No. 
A438 16 25X25 21
 COLOR : SC 長度可訂製



Model No. 
S091 單孔 28 30
 COLOR : 黑色



Model No. 
Z509 32 65 30
 COLOR : 黑色



Model No. 
AS041 單孔 25 23
 COLOR : SC



Model NO. 
S199 單孔 41 24



Model NO. 
S200 單孔 47X39 24



Model No. 
 S162 單孔 40x40 23



Model No. 
 S163 單孔 46x36 24



Model No. 
 S164 單孔 43x43 24



Model No. 
 S165 單孔 43x47 23



Model No. 
 S166 單孔 51x46 24



Model No. 
 S167 單孔 52x36 24



Model No. 
 S168 單孔 32x51 24



Model No. 
 S171 單孔 40x40 22



Model No. 
 S172 單孔 50x50 24

適用500pcs訂製品



Model No. 
 S175 單孔 37x34 23



Model No. 
 S176 單孔 43x37 23



Model No. 
 S177 單孔 32x25 24

適用500pcs訂製品



Model NO. 
 S208 單孔 50x48 24



Model NO. 
 S209 單孔 50x36 25



Model NO. 
 S211 單孔 53x53 24



Model NO. 
 S212 單孔 52x38 24



Model NO. 
 S213 單孔 54x34 25



Model NO. 
 S218 單孔 49x32 25



Model NO. 
 S219 單孔 54x37 25



Model NO. 
 S221 單孔 49x41 25



Model NO. 
 S222 單孔 48x41 25



Model NO. 
 S223 單孔 54x41 24



Model NO. 
 S224 單孔 52x35 24



Model NO. 
 S225 單孔 45x41 24



Model No.  ϕ | \emptyset | $\overline{\quad}$ | $\overline{\quad}$ | $\overline{\quad}$
Z759 96 139 33 22
 COLOR : AB+琉璃



Model No.  ϕ | \emptyset | $\overline{\quad}$ | $\overline{\quad}$ | $\overline{\quad}$
Z758 96 139 33 22
 COLOR : PC+琉璃



Model No.  ϕ | \emptyset | $\overline{\quad}$ | $\overline{\quad}$ | $\overline{\quad}$
ZS183 單孔 35 32
 COLOR : AB+琉璃



Model No.  ϕ | \emptyset | $\overline{\quad}$ | $\overline{\quad}$ | $\overline{\quad}$
ZS182 單孔 35x35 32
 COLOR : AB+琉璃



Model No.  ϕ | \emptyset | $\overline{\quad}$ | $\overline{\quad}$ | $\overline{\quad}$
ZS181 單孔 35 32
 COLOR : PC+琉璃



Model No.  ϕ | \emptyset | $\overline{\quad}$ | $\overline{\quad}$ | $\overline{\quad}$
ZS184 單孔 38x38 28
 COLOR : PC+琉璃



Model No.  ϕ | \emptyset | $\overline{\quad}$ | $\overline{\quad}$ | $\overline{\quad}$
ZS180 單孔 35x35 32
 COLOR : PC+琉璃



Model No.  ϕ | \emptyset | $\overline{\quad}$ | $\overline{\quad}$ | $\overline{\quad}$
ZS157 單孔 32 29
 COLOR : PC+琉璃



Model No.  ϕ | \emptyset | $\overline{\quad}$ | $\overline{\quad}$ | $\overline{\quad}$
ZS186 單孔 35 29
 COLOR : PC+琉璃



Model No.  ϕ | \emptyset | $\overline{\quad}$ | $\overline{\quad}$ | $\overline{\quad}$
ZS185 單孔 35 29
 COLOR : PC+琉璃



Model No.  ϕ | \emptyset | $\overline{\quad}$ | $\overline{\quad}$ | $\overline{\quad}$
ZS187 單孔 35 29
 COLOR : PC+琉璃



Model No.					
S174	單孔	20		23	
	單孔	25		27	
	單孔	30		32	
	單孔	35		34	

COLOR : WT



Model No.					
S155	單孔	30		28	

COLOR : WT



Model NO.					
AS193	單孔	25	27	25	

COLOR : GSB、BSN、AB



Model NO.					
ZS190	單孔	35		27	

COLOR : PC



Model NO.					
ZS191	單孔	32X32		25	

COLOR : PC



Model NO.					
ZS237	單孔	30		25	

COLOR : PC+GP



Model NO.					
ZS190	單孔	35		27	

COLOR : GP



Model NO.					
ZS191	單孔	32X32		25	

COLOR : GP 適用1000pcs訂製品

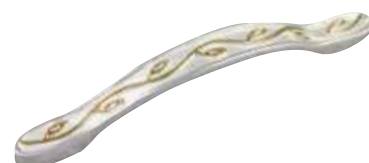

Model NO.					
Z794	96	117	23	15	
	128	155	24	15	

COLOR : PC+GP



Model No.					
ZS158	單孔	38x38		39	

COLOR : PC+琉璃



Model No.					
Z736	16	58	27	33	





COLOR : PC+琉璃







Model No.					
Z734	128	139	30	27	

COLOR : PC+琉璃







Model No.					
S195	單孔	42	38		
COLOR : WT 陶瓷					



Model No.					
S194	單孔	46	29		
COLOR : WT 陶瓷					







Model No.					
ZC03-S	單孔	60x32	16		
COLOR : 銀色+米黃					







Model No.					
ZC03-M	單孔	137x25	25		
COLOR : 銀色+米黃					







Model No.					
ZC29-S	單孔	126x20	15		
ZC29-M	單孔	150x24	18		
COLOR : 銀色+米黃					







Model No.					
ZC51-S	單孔	152x31	22		
ZC51-M	單孔	269x31	20		
COLOR : 銀色+米黃					



Model No.					
Z749	64	86	21		
	96	130	29		
COLOR : K金+白色 (左+右)/組					



Model No.					
Z749	64	86	21		
	96	130	29		
COLOR : 銀色+米黃 (左+右)/組					

把手系列—現代把手



Model No. 
ZS234 單孔 32 26
 COLOR : PC+GP



Model No. 
Z782 96 120 29 15
 128 160 31 16
 COLOR : PC+GP



Model No. 
ZS235 單孔 32 26
 COLOR : PC+GP

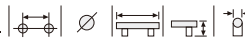

Model No. 
Z783 96 135 30 20
 128 180 31 22
 COLOR : PC+GP



Model NO. 
ZS227 單孔 33 32
 COLOR : PC+GP



Model No. 
Z774 96 108 27 17
 128 139 29 17
 160 173 35 17
 COLOR : PC+GP







Model NO. 
ZC233-S 單孔 151 25 26
 COLOR : PC+GP







Model NO. 
ZC233-M 單孔 223 30 30
 COLOR : PC+GP



Model NO.				
Z853	96	148	22	30
	128	180	24	30





COLOR **HAB**、**BK**



Model NO.				
Z854	128	170	24	22
	192	231	26	24
	256	303	27	24





COLOR **HAB**、**BK**



Model NO.				
Z856	96	135	23	20
	128	170	24	22





COLOR **HAB**、**BK**



Model NO.				
Z858	96	130	26	15
	128	160	26	16





COLOR **HAB**、**BK**



Model NO.				
ZS910	單孔	31	30	



COLOR **HAB**、**BK**



Model NO.				
Z859	96	127	28	27
	128	160	28	29



COLOR **HAB**



Model NO.			
ZS198	單孔	36x26	25



COLOR **AB**



Model NO.			
Z771	96	136	24
	128	176	38









COLOR **AB**



Model NO.			
Z749	64	84	21
	96	124	29

COLOR **HAB**、**銀色+米黃**、**K金+白色**
(左+右)組











Model NO.         

EC232-S 單孔 24 20

COLOR : **AB**











Model NO.         

EC232-M 單孔 33 21

COLOR : **AB**











Model NO.         

EC196-S 單孔 118 19

COLOR : **AB**











Model NO.         

EC196-M 單孔 172 25

COLOR : **AB**











Model NO.         

EC197-S 單孔 115 22

COLOR : **AB**











Model NO.         

EC197-M 單孔 150 25

COLOR : **AB**











Model NO.         

Z770 64 86 27



COLOR : **AB** 適用1000pcs訂製品



Model NO.         

Z770 96 128 29

COLOR : **AB**

Model No.					
Z585	96	111	24	20	
	128	144	24	20	

COLOR : AB · AG · GS

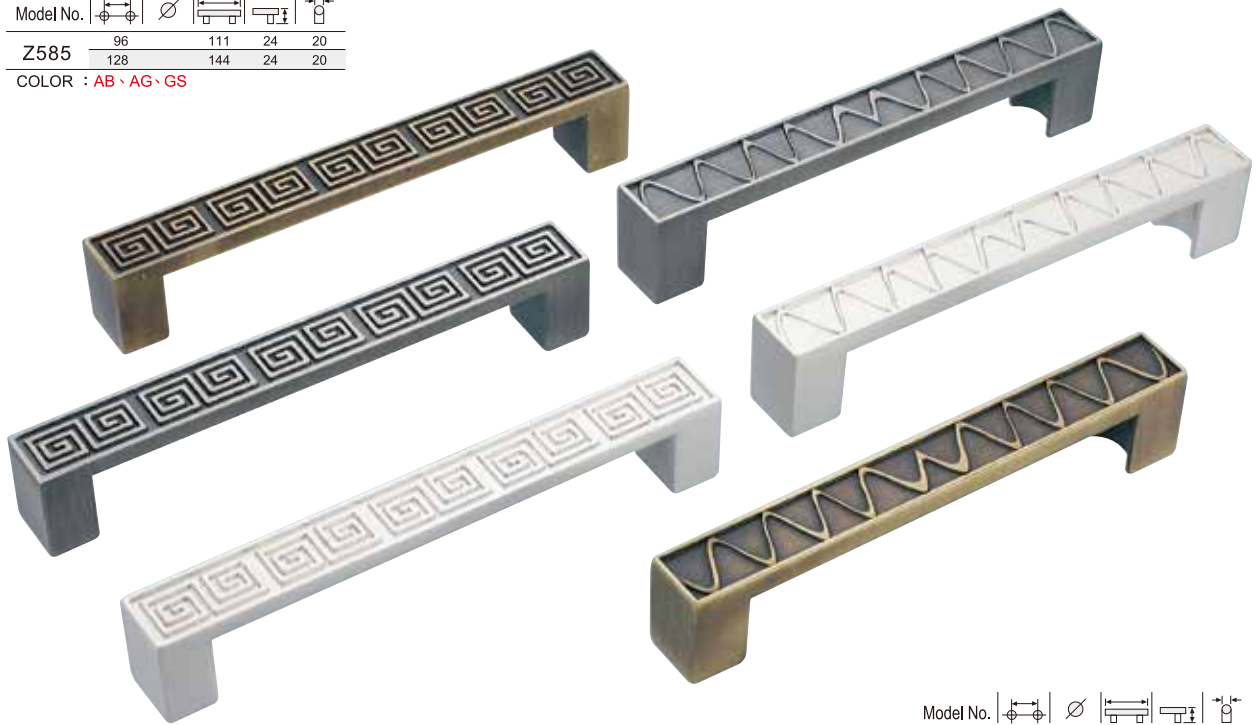

Model No.					
Z586	96	107	27	17	
	128	138	27	17	





COLOR : AB · AG · GS



Model No.					
ZS328	單孔	27x27		26	

COLOR : AG · AB · GS



Model No.					
ZS327	單孔	27x27		24	

COLOR : AG · AB · GS

把手系列—古典把手



Model No.
ZS303 單孔 30 25
 COLOR : AB



Model No.
ZS45 64 105 26 21
 96 124 29 19
 COLOR : AB



Model No.
ZS322 單孔 30x30 23
 COLOR : GS、AB



Model No.
ZS323 單孔 31x31 25
 COLOR : AB、GS



Model No.
ZS312 單孔 30 25
 COLOR : AB



Model No.
Z581 76 102 31 20
 COLOR : AB



Model No.
ZS316 單孔 33 26
 COLOR : AB 適用1000pcs訂製品



Model No.
Z582 76 101 26 17
 COLOR : AB

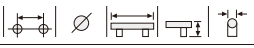

Model No. 
ZC111 單孔 109X42 16
 COLOR : **AB**



Model No. 
Z748

64	69x24	90x33	9
96	101x26	134x37	11
128	133x30	180x43	13

 COLOR : **HAB** 適用推門



Model No. 
ZC114 單孔 45X24 17
 COLOR : **AB**

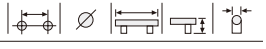

Model No. 
ZC113 96 120X46 17
 COLOR : **AB**

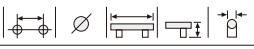

Model No. 
ZC159 單孔 33 30
 COLOR : **HAB**

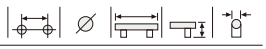

Model No. 
ZC161 96 115 21
 COLOR : **HAB**

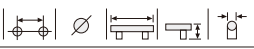

Model No. 
ZC160 96 116 21
 COLOR : **HAB**



Model No. 
ZC162 96 125 30 20
 COLOR : **HAB**

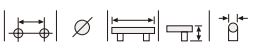

Model No. 
ZC108 單孔 40X30 20
 COLOR : AG、AB 適用1000pcs訂製品



Model No. 
ZC109 64 92 24
 COLOR : AG、AB



Model No. 
ZC104 單孔 54X16 16
 COLOR : AB



Model No. 
ZC102 96 116 25
 COLOR : AB



Model No. 
ZC107 單孔 32 25
 COLOR : AB



Model No. 
ZC102 96 116 25
 COLOR : AG

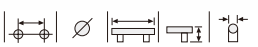

Model No. 
ZC101 96 116 27 42
 COLOR : AB



Model No. 
ZC101 96 116 27 42
 COLOR : AG 適用1000pcs訂製品



Model No.					
ZC24	單孔	156X12	31		

COLOR : HAB



Model No.					
ZC51-S	單孔	152X31	22		
ZC51-M	單孔	269X31	20		

COLOR : HAB、銀色+米黃



Model No.					
Z373	64	90	19		
	96	135	19		

COLOR : AB、GP、SN、T2 適用500pcs訂製品



Model No.					
Z744	96	111	27	24	
	128	144	33	28	

COLOR : HAB



Model No.					
Z745	96	139	28	21	
	128	173	29	21	

COLOR : HAB



Model No.					
ZS080	單孔	25X25	19		

COLOR : AB、BSN



Model No.					
Z482	96	109	35	20	

COLOR : AB、BSN



Model No.					
Z436	96	127	22	21	

COLOR : AB



Model No.					
ZS078-S	單孔	28X28	18		
ZS078-M	單孔	40X40	20		

COLOR : AB、SC、PC 適用500pcs訂製品



Model No.					
Z517	32	60X60	27		

COLOR : RAB 適用500pcs訂製品



Model No.					
ZC110-S	單孔	37	10		
ZC110-M	單孔	46	10		

COLOR : AB



Model No. 
ZC01

64	91	28
89	126	33

 COLOR : AB、SG 底座高度15mm



Model No. 
ZC02

-S 單孔	68X28	18
-M 單孔	92X34	20

 COLOR : AB、SG

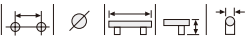

Model No. 
ZC03-M

單孔	139X25	16
----	--------	----

 COLOR : AB、SG、銀色+米黃



Model No. 
ZC03-S

單孔	60X32	16
----	-------	----

 COLOR : AB、SG、銀色+米黃



Model No. 
ZC05

單孔	110X45	17
----	--------	----

 COLOR : AB

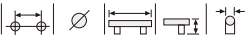

Model No. 
ZC06

-S 單孔	37	11
-M 單孔	45	13

 COLOR : AB



Model No. 
ZC08

單孔	30	18
----	----	----

 COLOR : AB



Model No. 
ZC09

單孔	24	17
----	----	----

 COLOR : AB

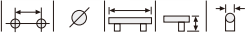

Model No. 
C10

單孔	29	20
----	----	----

 COLOR : AB

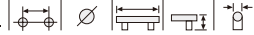

Model No. 
ZH13

單孔	50X33	18
----	-------	----

 COLOR : AB



Model No. 
ZC16

單孔	49X33	12
----	-------	----

 COLOR : AB



Model No. 
C18

單孔	37	26
----	----	----

 COLOR : AB

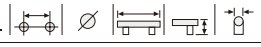

Model No. 
ZC19 單孔 64X19 16
 COLOR : AB

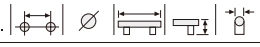

Model No. 
ZC21 單孔 70X41 14
 COLOR : AB



Model No. 
ZC22 64 88 14
 COLOR : AB



Model No. 
ZC23 單孔 55X36 16
 COLOR : AB

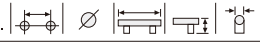

Model No. 
ZC25 32 93 15
 COLOR : AB



Model No. 
ZC27 96 129 13
 COLOR : AB



Model No. 
ZC29 ^{-S} 單孔 125X20 18
^{-M} 單孔 150X24 18
 COLOR : AB、銀色+米黃



Model No. 
ZC33 單孔 50X30 20
 COLOR : AB



Model No. 
ZC34-M 64 94X45 15
 COLOR : AB

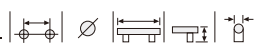

Model No. 
ZC34-S 32 60X28 10
 COLOR : AB



Model No. 
ZC36 ^{-S} 單孔 48X38 9
^{-M} 單孔 56X46 9
 COLOR : AB



Model No. 
ZC38-M 單孔 96X33 16
 COLOR : AB 適用500pcs訂製品



Model No.
ZC38-S 單孔 47X33 16
 COLOR : AB



Model No.
ZC39 64 96X42 16
 COLOR : RAB 適用500pcs訂製品



Model No.
ZC40-M 64 81X44 11
 COLOR : AB



Model No.
ZC40-S 32 63X34 8
 COLOR : AB



Model No.
ZC42-M 64 96X41 16
 COLOR : RAB 適用500pcs訂製品



Model No.
ZC42-S 單孔 53X32 16
 COLOR : RAB 適用500pcs訂製品



Model No.
ZC43-M 單孔 45X40 16
 COLOR : HAB



Model No.
ZC43-S 單孔 40X33 16
 COLOR : HAB



Model No.
ZC47 單孔 59X42 12
 COLOR : AB



Model No.
ZC49 單孔 270 45
 COLOR : AB



Model No.
ZH55 單孔 44X33 18
 COLOR : AB



Model No.
ZC62 單孔 30 19
 COLOR : AB

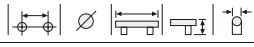

Model No. 
ZC64 單孔 37 15
 COLOR : AB 通用500pcs訂製品



Model No. 
ZC66-S 單孔 32 17
 COLOR : HAB、PC

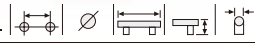

Model No. 
ZC67-M 單孔 30 19
 COLOR : AB、RAB



Model No. 
ZC67-S 單孔 25 18
 COLOR : AB、RAB

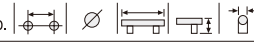

Model No. 
ZC70 單孔 195 20
 COLOR : AB

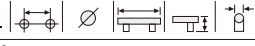

Model No. 
ZC73-M 83 105X53 18
 COLOR : AB 通用500pcs訂製品



Model No. 
ZC73-S 64 82X41 13
 COLOR : AB

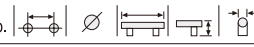

Model No. 
ZC75 -S 64 78X54 17
 -M 96 115X79 17
 COLOR : AB 通用500pcs訂製品



Model No. 
ZC76-M 單孔 30 19
 COLOR : AB



Model No. 
ZC76-S 單孔 24 16
 COLOR : AB



Model No. 
ZC84-M 24 95X52 15
 COLOR : AB



Model No. 
ZC88-M 單孔 30 22
 COLOR : AB



Model No. 
ZC88-S 單孔 25 20
 COLOR : AB

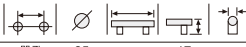

Model No. 
ZC89 -S 單孔 25 17
 -M 單孔 32 22
 COLOR : HAB



Model No. 
ZC90 -S 單孔 59 10
 -M 單孔 66 12
 COLOR : AB



Model No. 
ZC92 單孔 65X33 19
 COLOR : AB



Model No. 
ZC93 單孔 65X33 19
 COLOR : AB



Model No. 
ZC94 單孔 54X37 16
 COLOR : AB



Model No. 
ZC95 單孔 52X48 15
 COLOR : AB



Model No. 
ZC97 單孔 42X25
 COLOR : AB



Model No. 
ZS040 -S 單孔 24 21
 -M 單孔 29 21
 COLOR : AB

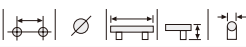

Model No. 
ZS045 -S 單孔 18X18 21
 -M 單孔 24X24 23
 COLOR : AB、SC

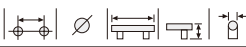

Model No. 
ZS047 單孔 20 22
 COLOR : AB



Model No. 
ZS048 單孔 52X18 22
 COLOR : AB



Model No. 
ZS071-M 單孔 32 24
 COLOR : AB、AG



Model No. 
ZS071-S 單孔 27 22
 COLOR : AG、AB

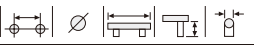

Model No. 
Z418-S 35 48 10
 COLOR : AB

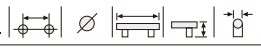

Model No. 
ZE213 76 120
 COLOR : AB

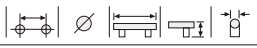

Model No. 
Z217 單孔 110X24 21
 COLOR : AB

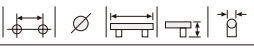

Model No. 
ZC70 單孔 195 20
 COLOR : AB

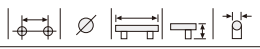

Model No. 
ZY10-S 175X40 6
 COLOR : AB

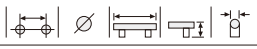

Model No. 
ZY11 單孔 50X50 10
 COLOR : AB

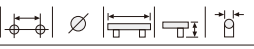

Model No. 
ZY14 單孔 54 8
 COLOR : AB



Model No. 
ZY15 單孔 43 7
 COLOR : AB



Model No. 
ZY17 單孔 46X30 6
 COLOR : AB



Model No. 
ZY19 無孔 53X29 3
 COLOR : AB

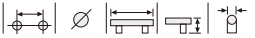

Model No. 

S	13
M	18
L	22
XL	28

ZY20
COLOR : SC、PC、AB

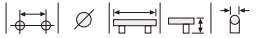

Model No. 

S	15X15
M	20X20
L	25X25
XL	30X30

ZY21
COLOR : SC、PC、AB



Model No. 

ZY22	單孔	54	8
------	----	----	---

COLOR : AB



Model No. 

ZY23	32	105X45
------	----	--------

COLOR : AB



Model No. 

ZY24	單孔	55X54	14
------	----	-------	----

COLOR : AB



Model No. 

ZY25	-S 單孔	33	8
	-M 單孔	38	11

COLOR : AB



Model No. 

ZY26	單孔	56X56	13
------	----	-------	----

COLOR : AB
適用500pcs訂製品



Model No. 

ZY27	單孔	39X35	9
------	----	-------	---

COLOR : AB



Model No. 

ZY28	單孔	38	8
------	----	----	---

COLOR : AB



Model No. 

ZY29	單孔	38	8
------	----	----	---

COLOR : AB
適用500pcs訂製品



Model No. 

ZY30-S	43	62X20	6
--------	----	-------	---

COLOR : AB



Model No. 

630	100X15
	100X15
	100X15

COLOR : 米黃、米白、咖啡

Model No. A446

197、297、397、447、497、597、697、797、897、997
 COLOR : SC · ED · GBK 長度可訂製



A446 (適用6分板)

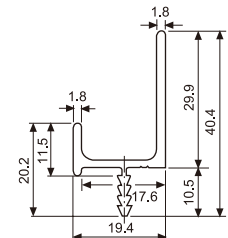
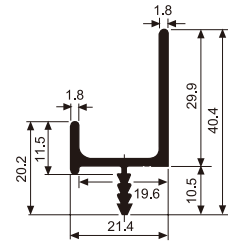

A446-1 (適用6分木芯板
 長度為訂製品)

Model No. A447

197、297、397、447、497、597、697、797、897、997
 COLOR : SC · ED 長度可訂製

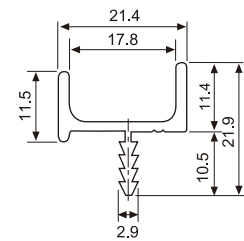

Model No. A454

197、297、397、447、497、597、697、797、897、997
 COLOR : SC 訂製品

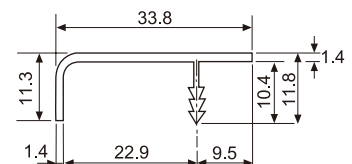

Model No. A533

197、297、397、447、497、597、697、797、897、997
 COLOR : SC、ED、GBK 長度可訂製



A533

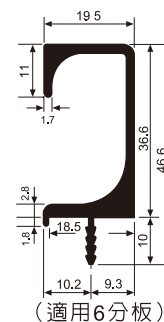

Model No. A533-1

197、297、397、447、497、597、697、797、897、997
 COLOR : SC、ED、GBK 長度可訂製



A533-1

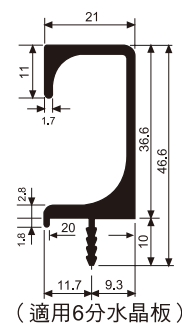

Model No. A555

197、297、397、447、497、597、697、797、897、997
 COLOR : SC、ED、GBK 訂製品

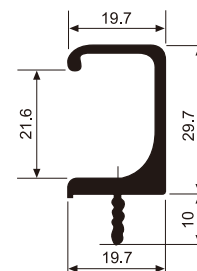

Model No. A547



COLOR : SC

訂製品

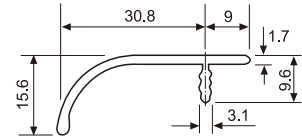

Model No. A548



COLOR : SC · ED

訂製品

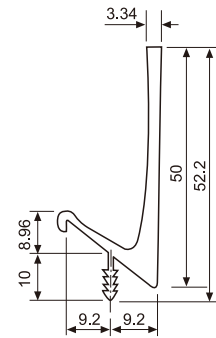

施工角度39°

Model No. A549



COLOR : SC · ED

訂製品

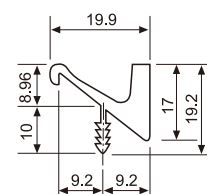

施工角度39°

Model No. A522

197、297、397、447、497 597、697、797、897、997
 COLOR : SC、ED 長度可訂製

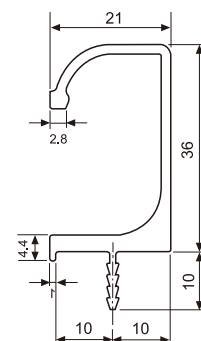

Model No. A564

197、297、397、447、497、597、697、797、897、997
 COLOR : SC、ED 長度可訂製

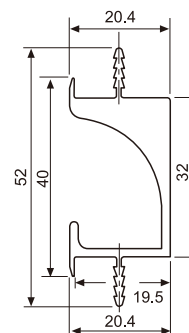

Model No. A454-1

COLOR : SC、ED 訂製品

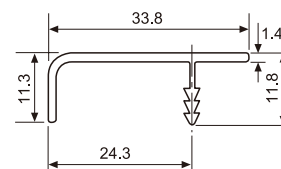

Model No. 
 A567 3米
 A567-1 3米
 COLOR : SC、GBK 長度可訂製



把手固定座

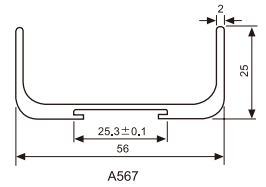
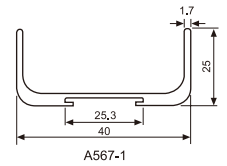

Model No. A590 封邊把手
 8尺、10尺/支
 COLOR : SC、GBK 長度可訂製

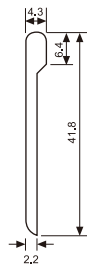

Model No. A599 封邊把手
 長度可訂製
 COLOR : SC、GBK 長度可訂製

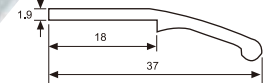
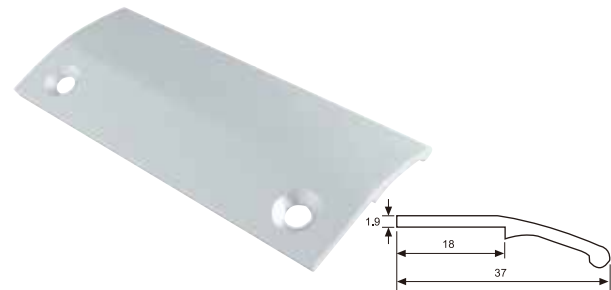

Model No. A357 封邊把手
 7尺、8尺、10尺/支
 COLOR : SC、GBK 長度可訂製

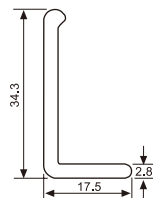

Model No. A568 封邊把手
 8尺、10尺/支
 COLOR : SC、GBK 長度可訂製

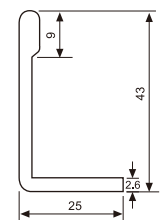

Model No. 459144 封邊把手
 長度可訂製
 COLOR : SC 長度可訂製

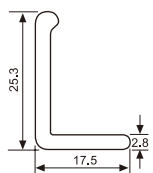

Model No. 459179 封邊把手
 7尺、8尺、10尺/支
 COLOR : SC 長度可訂製

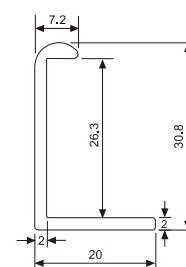



AF73



顏色：鋁色、黑色
腳座尺寸：25X25mm，長、寬、高皆可訂製尺寸。



AF74

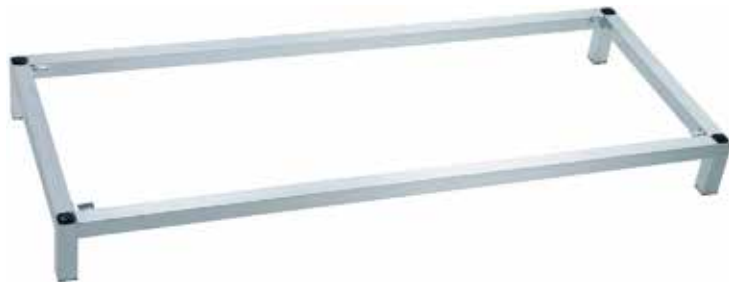

顏色：鋁色、黑色
腳座尺寸：38X38mm，長、寬、高皆可訂製尺寸。



AF113





顏色：鋁色、黑色
腳座尺寸：腳60X60mm，四邊上框架70mm
長、寬、高皆可訂製尺寸。



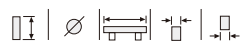

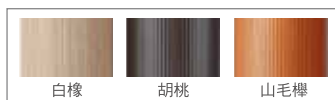
Model No. |  |
F38 730 60
 COLOR : 白橡 可加裝輪子



Model No. |  |
F38 730 60
 COLOR : 黑色 可加裝輪子

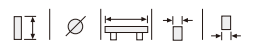

Model No. |  |
F38 730 60
 COLOR : SC 可加裝輪子

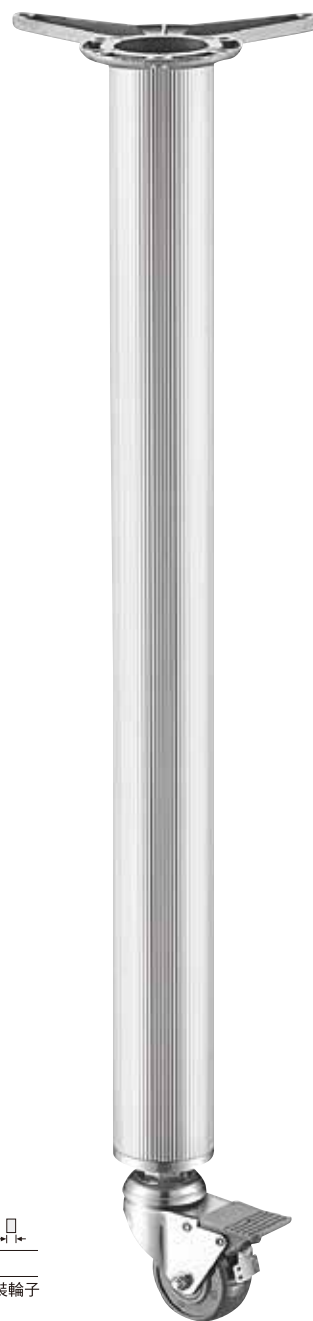

Model NO. |  |
F38-B 730 60
 COLOR : SC、黑色 活動輪桌腳(可訂製)
 高度可調1.5cm

※本頁產品特性：
 1.F38可調整高度25mm
 2.材質為鋁合金
 3.高度可接受訂製



Model No. | |
F95 712 58
 COLOR : SC 鋁合金 活動輪桌腳



Model No. | |
F100 715 60X60
 COLOR : SC 高度可訂製



Model No. | |
F80 720 26X50
 COLOR : SC 鋁合金 折疊桌腳



Model No. | |
F97 720 30
 COLOR : PC 鐵 可調整高度8mm



Model No.	Height	Width	Depth
AF40	100	70	40
	130	70	40

COLOR : SC



Model No.	Height	Width	Depth
AF32	80	90	35
	100	90	35
	130	90	35
	160	90	35
	200	90	35

COLOR : BSN 高度可訂製



Model No.	Height	Width
AF52	100	45
	120	45
	150	45

COLOR : SC、BSN、胡桃木、山毛櫸、白橡

- ※產品特性：
1. 調整高度30mm，由上座調整
 2. 外表顏色為烤漆處理
 3. 高度可接受訂製



Model No. | | | | |

AF24	120		75	
------	-----	--	----	--

COLOR : BSN



Model No. | | | | |

AF53	75	90X55		
------	----	-------	--	--

COLOR : BSN 寬度可訂製



Model No. | | | | |

AF22	120		75	
------	-----	--	----	--

COLOR : BSN



Model No. | | | | |

AF36	70	79	25
	100	79	25
	130	79	25

COLOR : SC · GBK 高度可訂製



Model No. | | | | |

AF34	70	79	51
	100	79	51
	130	79	51

COLOR : SC 高度可訂製



Model No. | | | | |

AF35	70	79	38
	100	79	38
	130	79	38

COLOR : SC · GBK 高度可訂製



Model No.					
AF56	100	35			
	120	35			
	150	35			

COLOR : BSN+胡桃木



Model No.					
AF110	99		44	42	

COLOR : SC



Model No.					
AF111	99		44	44	

COLOR : SC



Model No.					
ZF01	97	60x67	35		
	140	60x67	35		

COLOR : SN+胡桃木



Model No.					
ZF01	50	60x67			
	71	60x67			

COLOR : SN



Model No.					
ZF01	97	60x67	35		
	140	60x67	35		

COLOR : SN+山毛櫸



Model No.					
ZF02	118		60		

COLOR : SN



Model No.					
AF57	100	35	90		
	130	35	90		

COLOR : SC 高度可訂製



Model No.					
AF10	143				

COLOR : BSN



Model No.	□	∅	≡	≡	≡
AF56	80	35	60x67		
	100	35	60x67		
	120	35	60x67		
	150	35	60x67		
	180	35	60x67		
	200	35	60x67		

COLOR : BSN 高度可訂製



Model NO.	□	∅	≡	≡	≡
AF81	100	37	38.5	37	36
	130	37	38.5	37	36

COLOR : SC



Model NO.	□	∅	≡	≡	≡
AF82	100	53	56	53	52
	130	53	56	53	52

COLOR : SC



Model No.	□	∅	≡	≡	≡
AF98	100	40	69		
	130	40	69		

COLOR : PC+SC、BK+SC 高度可訂製

※產品特性：
調整高度20mm，由上座調整



Model No.	□	∅	≡	≡	≡
AF99	100	50	79		
	130	50	79		

COLOR : PC+SC 高度可訂製

※產品特性：
調整高度20mm，由上座調整



Model No.	□	∅	≡	≡	≡
F109	120	50	66		

COLOR : BSN #202



Model No.	□	∅	≡	≡	≡
AF35	70		79	38	
	100		79	38	
	130		79	38	

COLOR : SC、GBK 高度可訂製



Model No.	□	∅	≡	≡	≡
AF36	70		79	25	
	100		79	25	
	130		79	25	

COLOR : SC、GBK 高度可訂製



※產品特性：
1.調整高度30mm，由下座調整
2.材質為塑膠
3.可鎖鋁踢腳板

Model No.	□	∅	≡	≡	≡
F96	100				

COLOR : 黑



Model No.	煞車		 mm	 mm
HD102	有		97	60X60
	無		97	60X60



Model No.	煞車		 mm	 mm
HD104	有		65	42X42
	無		65	42X42



Model No.	煞車		 mm	 mm
HD101	有		97	60X60
	無		97	60X60



Model No.	煞車		 mm	 mm
HD106	有		65	42X42
	無		65	42X42



Model No.	煞車		 mm	 mm
SKA75	有		98	60X60
	無		98	60X60



Model No.	煞車		 mm	 mm
SKA50	有		65	42X42
	無		65	42X42



Model No.	煞車			
HD111	有	∅75	97	60X60
	無	∅75	97	60X60



Model No.	煞車			
HD103	有	∅75	97	60X60
	無	∅75	97	60X60



Model No.	煞車			
HD504	有	∅40	54	38X38
	無	∅40	54	38X38



Model No.	煞車			
HD105	有	∅60	87	

3分牙



Model No.	煞車			
HD110	有	∅52	70	47X47
	無	∅52	70	47X47



Model No.	煞車			
HD108	有	∅40	60	34X34
	無	∅40	60	34X34
HD109	有	∅41	58.5	34X34
	無	∅41	58.5	34X34



Model No.	煞車		 L _{mm}	 mm
HD112	有	∅50	63	42X42
	無	∅50	63	42X42



Model No.	煞車		 L _{mm}	 mm
HD113	有	∅75	96	60X60
	無	∅75	96	60X60



Model No.	煞車		 L _{mm}	 mm
HD116	有	∅60	95	47X47
	無	∅60	95	47X47



Model No.	煞車		 L _{mm}	 mm
HD117	有	∅75	109	47X47
	無	∅75	109	47X47



Model No.	煞車		 L _{mm}	 mm
HD114	有	∅50	63	42X42
	無	∅50	63	42X42



Model No.	煞車		 L _{mm}	 mm
HD115	有	∅75	96	60X60
	無	∅75	96	60X60

一代四孔西德鉸鏈



產品對照表

品 編	規 格
WA16	蓋六分
WA13	蓋三分
WA10	入柱

※4孔底座

- 開啟角度：105°
- 杯孔距：48mm
- 鉸杯厚度：11.3mm
- 鉸杯直徑：35mm
- 面板 (K) 尺寸：3mm~6mm
- 門可選用板厚：14mm~26mm

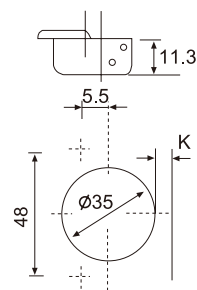

- Opening angle : 105°
- Hole space of hinge cup : 48mm
- Depth of hinge cup : 11.3mm
- Diameter of hinge cup : 35mm
- Door dimension (K) : 3mm~6mm
- Range of doors thickness : 14mm~26mm

三代快拆西德鉸鏈

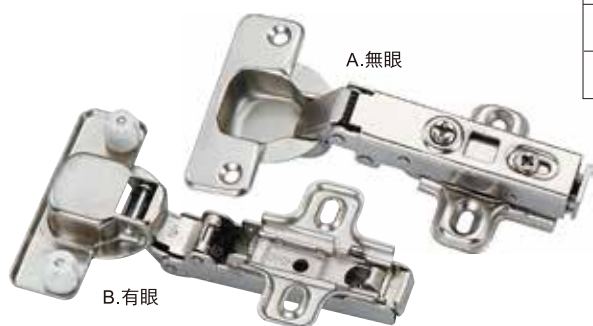

產品對照表

品 編	規 格
WF36	蓋六分
WF360	蓋六分有限

- 開啟角度：110°
- 杯孔距：52mm
- 鉸杯厚度：11.3mm
- 鉸杯直徑：35mm
- 面板 (K) 尺寸：3mm~7mm
- 門可選用板厚：14mm~27mm

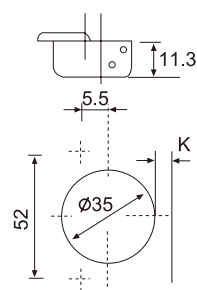

- Opening angle : 110°
- Hole space of hinge cup : 52mm
- Depth of hinge cup : 11.3mm
- Diameter of hinge cup : 35mm
- Door dimension (K) : 3mm~7mm
- Range of doors thickness : 14mm~27mm



H15B 窄鋁框鉸鏈 (緩衝)

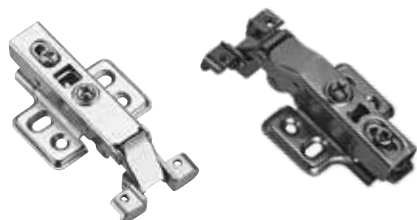

產品對照表

品 編	規 格
H15B36	蓋六分
H15B33	蓋三分
H15B30	入柱

※4孔底座

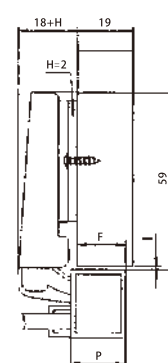
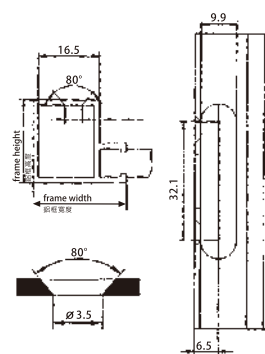
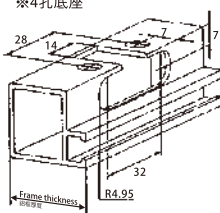

H1 玻璃鉸鏈



產品對照表

品 編	規 格
H1	蓋六分
H2	蓋三分
H3	入柱

※4孔底座

- 開啟角度：95°
- 鉸杯厚度：11.3mm
- 鉸杯直徑：26mm
- 面板 (K) 尺寸：3mm~6mm
- 面蓋材料：ABS

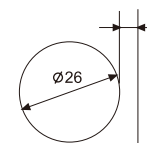

- Opening angle : 95°
- Depth of hinge cup : 11.3mm
- Diameter of hinge cup : 26mm
- Door dimension (K) : 3mm~6mm
- Surface material : ABS



材質：ABS

S1 175° 鉸鏈



產品對照表

品 編	規 格
S1-4	蓋六分 4孔底座

- 開啟角度：175°
- 杯孔距：48mm
- 鉸杯厚度：11.3mm
- 鉸杯直徑：35mm
- 面板 (K) 尺寸：4mm~6mm
- 門可選用板厚：14mm~25mm

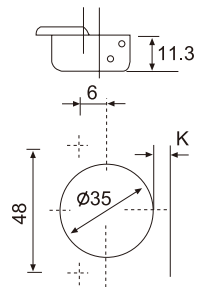

- Opening angle：175°
- Hole space of hinge cup：48mm
- Depth of hinge cup：11.5mm
- Diameter of hinge cup：35mm
- Door dimension (K)：4mm~6mm
- Range of doors thickness：14mm~25mm

FA 105° 短臂型鉸鏈



適用蓋5分

側板D蓋位計算表：

D	K	蓋位		
		4	5	6
0	0	15	16	17

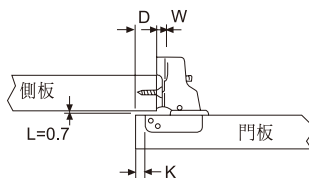

安裝底座

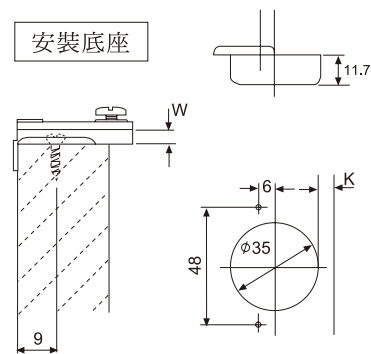

H21 厚門緩衝鉸鏈



● 產品對照表 ●

品 編	規 格
H213503-6	蓋 6 分
H213503-3	蓋 3 分
H213503-0	入 柱

- 開啟角度：110°
- 杯孔距：52mm
- 鉸杯厚度：15mm
- 鉸杯直徑：40mm
- 門板 (K) 尺寸：4~5mm
- 門可選用板厚：24~28mm

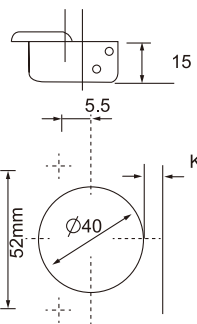

- Opening angle：110°
- Hole space of hinge cup：52mm
- Depth of hinge cup：15mm
- Diameter of hinge cup：40mm
- Door dimension (K)：4~5mm
- Range of doors thickness：24~28mm

H1002 進口側門緩衝器



(6分、3分、入柱通用)



加高墊



H20 油壓鉸鏈 (快拆型)



產品對照表

品 編	規 格
H20	蓋6分
	蓋3分
	入柱

※4孔底座

- 開啟角度： 105°
- 杯孔距： 48mm
- 鉸杯厚度： 11.3mm
- 鉸杯直徑： 35mm
- 面板 (K) 尺寸： 3mm~7mm
- 門可選用板厚： 14mm~24mm

- Opening angle： 105°
- Hole space of hinge cup： 48mm
- Depth of hinge cup： 11.3mm
- Diameter of hinge cup： 35mm
- Door dimension (K)： 3mm~7mm
- Range of doors thickness： 14mm~24mm

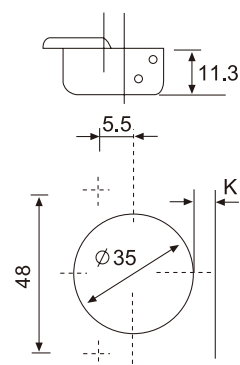

H17 反彈鉸鏈組合

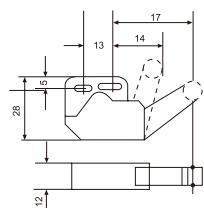

產品對照表

品 編	規 格
H1713	蓋三分

杯孔距:48mm



關門



按壓



自動彈開

K2916 天地鉸鏈

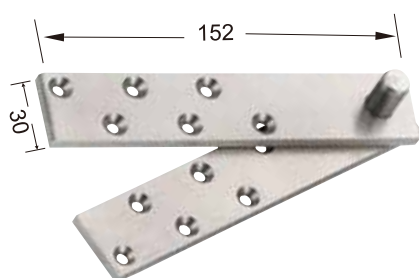

H7 平台鉸鏈



材質：鋅合金
Material : GB zinc alloy
表面處理：鍍(SN)
Finish : Nickel

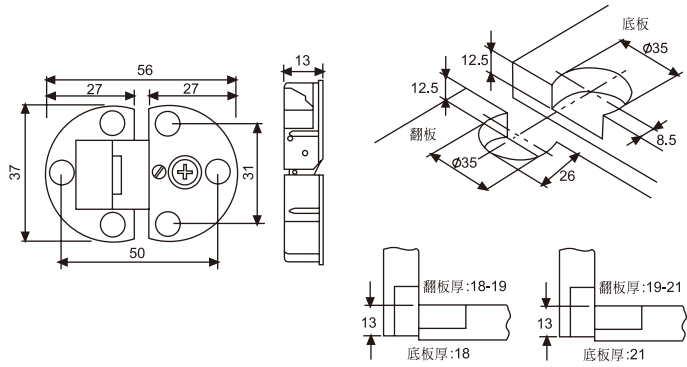

K2910



材質：鋅合金
Material : GB zinc alloy
表面處理：鍍(PC)
Finish : Chromium

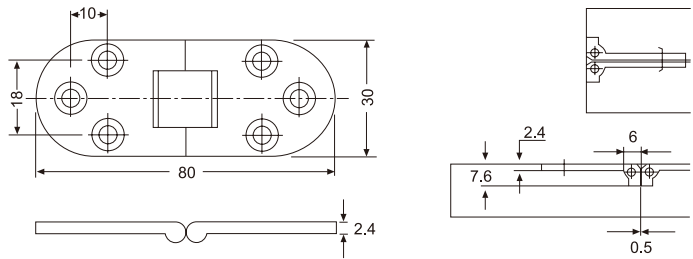

K2910-1



材質：鐵
Material : Iron
表面處理：古典(AB)
Finish : Traditions Copper

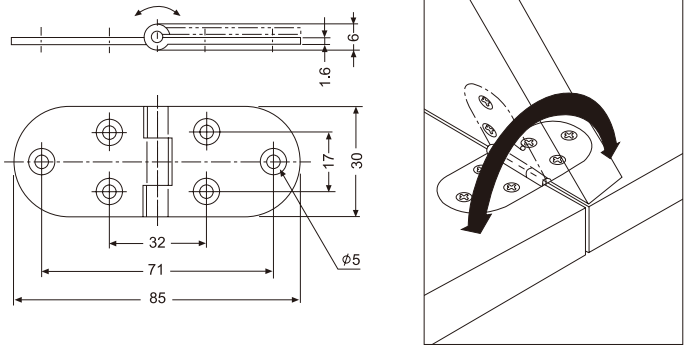

K2907 暗鉸鏈 (暗丁雙)



材質：鋅合金
Material : GB zinc alloy
表面處理：鍍(SN)、金(GP)
Finish : Chromium、Gold

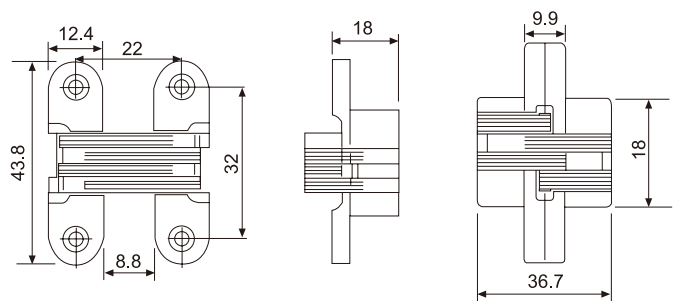

HM709 三節隱藏式緩衝滑軌 (快拆式)

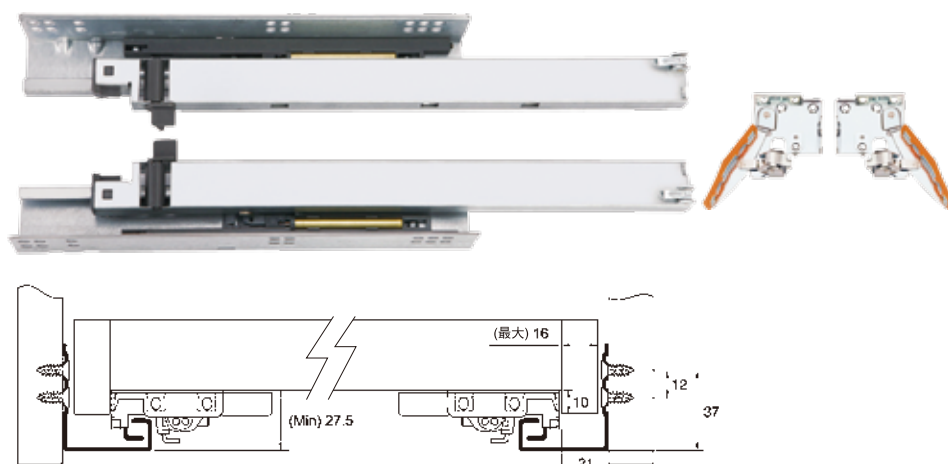

★隱藏式全拉出緩衝滑軌

- 長度：300、350、400、450、500mm
- 安裝：底部安裝
- 承重：30Kg
- 表面：鐵鍍鋅
- 優點：帶快速拆裝扣手，抽屜可快速安裝與拆卸，抽屜面板高度間隙可調1-3mm

HM710 二節隱藏式緩衝滑軌 (快拆式)

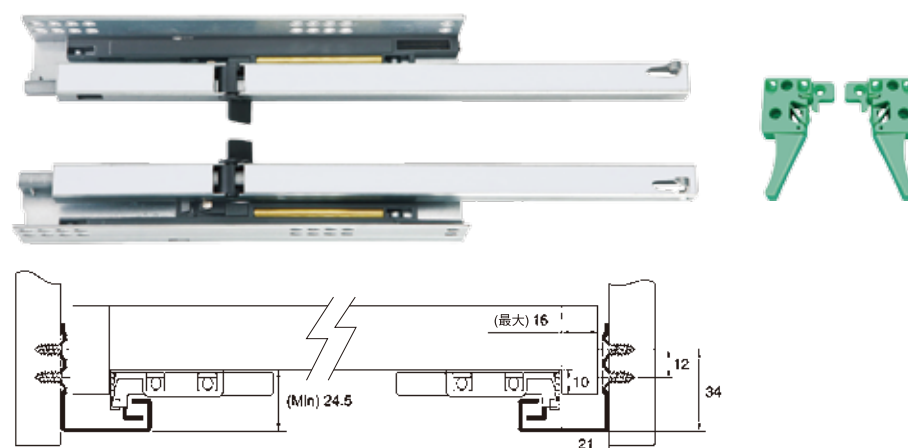

★隱藏式半拉出緩衝滑軌

- 長度：300、350、400、450、500mm
- 安裝：底部安裝
- 承重：30Kg
- 表面：鐵鍍鋅
- 優點：帶快速拆裝扣手，抽屜可快速安裝與拆卸，抽屜面板高度間隙可調1-3mm

HM708 自動回歸緩衝三節抽底滑軌 (插銷式結合器)

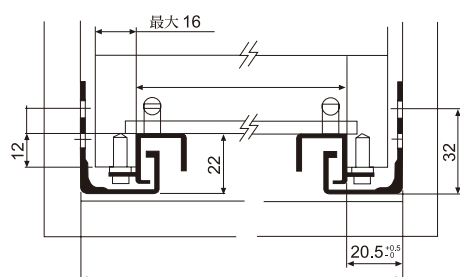

★自動回歸緩衝三節抽底滑軌

- 長度：300、350、400、450、500mm
- 安裝：底部安裝
- 承重：30Kg
- 表面：鐵鍍鋅
- 優點：輕巧的緩衝關閉裝置可自動地使抽屜達到緩衝關閉效果，防止抽屜意外打開。

H3601 三節抽中滑軌



★ 三節抽中滑軌

- 長度：250、300、350、400、450、500、550、600mm
- 安裝：側面安裝、間隙13mm+0.2mm
- 承重：35Kg/450mm(18")
- 表面：鍍白鋅
- 優點：全展拉出靜音滑軌，帶定位器，防滑出保護件。滑軌可以通過一個脫鉤分開，使抽屜的安裝和拆卸變得十分方便。

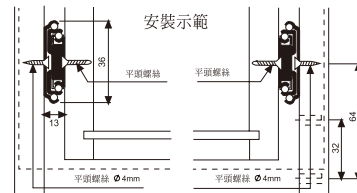

★ Three Fold Steel Ball Slide

- Length : 250、300、350、400、450、500、550、600mm
- Install : side install ,interval 13mm+0.2mm
- Load : 35kg/450mm(18")
- Surface : Galvanized-zinc
- Advantage : Full-drawing silent voice slide with a positioner and anti-skid device. Slide may pass a disconnect separately so it become very convenient for installing and dismantling with hanging drawer.

安裝寬度13mm，誤差調節+0.2mm
Width 13mm Error Adjustable Flat Screw+0.2mm

H3618 自動回歸三節抽中滑軌



★ 三節抽中滑軌

- 長度：350、400、450、500 mm
- 安裝：側面安裝、間隙13mm
- 承重：35Kg/450mm(18")
- 表面：鍍白鋅
- 優點：全拉出靜音滑軌，輕巧的自鎖關閉裝置可自動地使抽屜達到緊閉效果，防止抽屜意外打開。輕鬆的滑入安裝設計與鎖定設計，更具易裝易拆的功能。

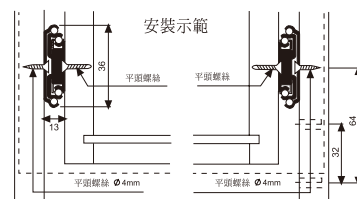

★ Auto-Return Three Fold Steel Ball Slide

- Length : 350、400、450、500 mm
- Install : side install ,interval 13mm
- Load : 35kg/450mm(18")
- Surface : Galvanized-zinc
- Advantage : Full-drawing silent voice slide, Simple self-locked -closed device may be drawing automatic to reach closed effect prevent drawer open by accident. Flexible slide and controlled design had easily installed and dismantled function.

安裝寬度13mm，誤差調節+0.2mm
Width 13mm Error Adjustable Flat Screw+0.2mm

HT4501A 三節抽中滑軌



★ 三節抽中滑軌

- 長度：300、350、400、450 mm
- 安裝：側面安裝、間隙13.2mm+0.2mm
- 承重：45Kg/450mm(18")
- 表面：鍍白鋅
- 優點：全展拉出靜音滑軌，帶定位器，防滑出保護件。滑軌可以通過一個脫鉤分開，使抽屜的安裝和拆卸變得十分方便。

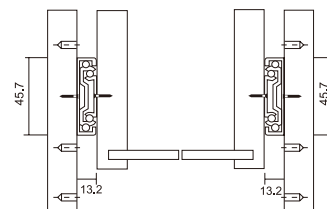

★ Three Fold Steel Ball Slide

- Length : 300、350、400、450mm
- Install : side install ,interval 13.2mm+0.2mm
- Load : 45kg/450mm(18")
- Surface : Galvanized-zinc
- Advantage : Full-drawing silent voice slide with a positioner and anti-skid device. Slide may pass a disconnect separately so it become very convenient for installing and dismantling with hanging drawer.

安裝寬度13.2mm，誤差調節+0.2mm
Width 13.2mm Error Adjustable Flat Screw+0.2mm

H3601A 三節抽底滑軌



- ★ 三節抽底滑軌
- 長度：250、300、350、400、450、500、550、600mm
- 安裝：側面安裝、間隙13mm
- 承重：35Kg/450mm(18")
- 表面：鍍白鋅
- 優點：全拉出靜音滑軌，輕巧的自鎖關閉裝置可自動地使抽屜達到緊閉效果，防止抽屜意外打開。輕鬆的滑入安裝設計與鎖定設計，更具易裝易拆的功能。

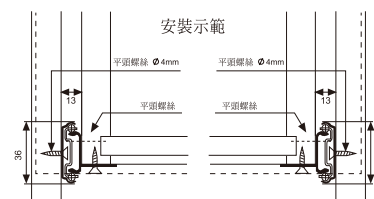

安裝寬度13mm，誤差調節+0.2mm
Width 13mm Error Adjustable Flat Screw+0.2mm

- ★ Auto-Return Three Fold Steel Ball Slide
- Length : 250、300、350、400、450、500、550、600mm
- Install : side install ,interval 13mm
- Load : 35kg/450mm(18")
- Surface : Galvanized-zinc
- Advantage : Full-drawing silent voice slide, Simple self-locked -closed device may be drawing automatic to reach closed effect prevent drawer open by accident. Flexible slide and controlled design had easily installed and dismantled function.

HT4502 三節微緩衝抽中滑軌

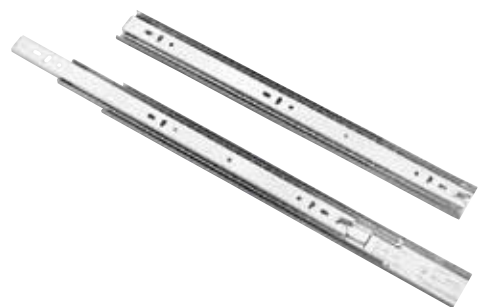

- ★ 三節微緩衝抽中滑軌
- 長度：350、400、450mm
- 安裝：側面安裝、間隙12.6mm
- 承重：45Kg/450mm(18")
- 表面：鍍白鋅
- 優點：全拉出靜音滑軌，輕巧的自鎖關閉裝置可自動地使抽屜達到緊閉效果，防止抽屜意外打開。輕鬆的滑入安裝設計與鎖定設計，更具易裝易拆的功能。

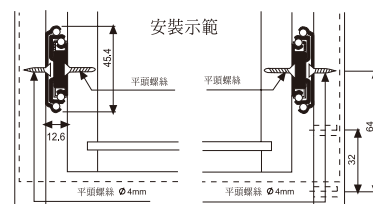

安裝寬度 12.6 mm，誤差調節+0.2mm
Width 12.6 mm Error Adjustable Flat Screw+0.2mm

- ★ Auto-Return Three Fold Steel Ball Slide
- Length : 350、400、450mm
- Install : side install ,interval 12.6mm
- Load : 45kg/450mm(18")
- Surface : Galvanized-zinc
- Advantage : Full-drawing silent voice slide, Simple self-locked -closed device may be drawing automatic to reach closed effect prevent drawer open by accident. Flexible slide and controlled design had easily installed and dismantled function.

HT4536 新型三節緩衝滑軌



- ★ 新型三節緩衝滑軌
- 長度：300、350、400、450、500mm
- 安裝：側面安裝、間隙13mm
- 承重：35Kg/450mm(18")
- 表面：鍍白鋅
- 優點：全拉出靜音滑軌，輕巧的自鎖關閉裝置可自動地使抽屜達到緊閉效果，防止抽屜意外打開。輕鬆的滑入安裝設計與鎖定設計，更具易裝易拆的功能。

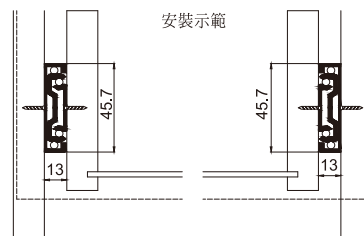

安裝寬度13mm，誤差調節+0.2mm
Width 13mm Error Adjustable Flat Screw+0.2mm

- ★ Auto-Return Three Fold Steel Ball Slide
- Length : 300、350、400、450、500mm
- Install : side install ,interval 13mm
- Load : 35kg/450mm(18")
- Surface : Galvanized-zinc
- Advantage : Full-drawing silent voice slide, Simple self-locked -closed device may be drawing automatic to reach closed effect prevent drawer open by accident. Flexible slide and controlled design had easily installed and dismantled function.

HM231 按壓式自彈三節滑軌

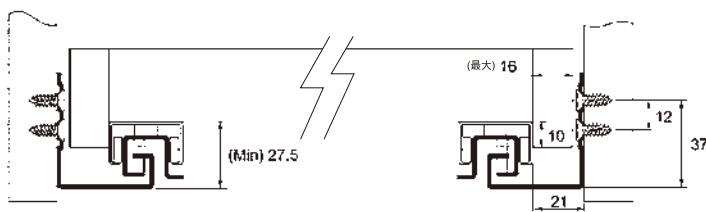

★隱藏式全拉出反彈滑軌

- 長度：300、350、400、500mm
- 安裝：底部安裝
- 承重：30Kg
- 表面：鐵鍍鋅
- 優點：帶側板插銷，抽屜的安裝與拆卸免工具，抽屜面板高度間隙可調 1-3mm

HM230 按壓式自彈二節滑軌



抽屜（關）



按壓



自動彈開

★按壓式自彈滑軌

- 長度：350、400、450、500mm
- 安裝：底部安裝
- 承重：30Kg
- 表面：鐵鍍鋅
- 優點：不需裝置把手，輕巧一按自彈關閉裝置可自動地使抽屜達到彈出效果，且有防止抽屜意外打開之功能。

L9056 單鉤



材質：不鏽鋼、鐵兩種

L9057 雙鉤



材質：不鏽鋼、鐵兩種

L9082 鋁質酒杯架(單排)



尺寸：111x400mm

L9082 鋁質酒杯架(雙排)



尺寸：215x400mm

L9082 鋁質酒杯架(三排)

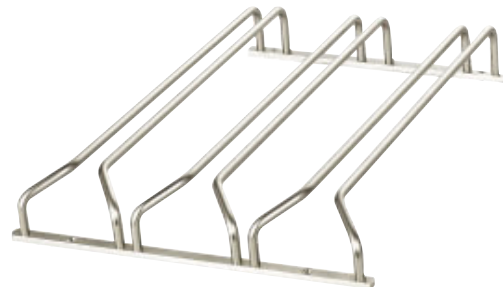

尺寸：319x400mm

L9081ST 不鏽鋼酒杯架



204

單排 尺寸：110x340mm
雙排 尺寸：215x340mm

L9081 鐵質酒杯架(三排)



尺寸：301x347mm

L9081 鐵質酒杯架(四排)



尺寸：401x346mm

L9084ST 不鏽鋼馬克杯架

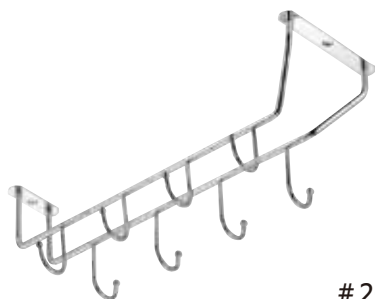

204

尺寸：105x315mm

L6003 五邊勾



長度35cm

L6004 鞋架



長度32.5cm

ECO77 鋁合金掛勾

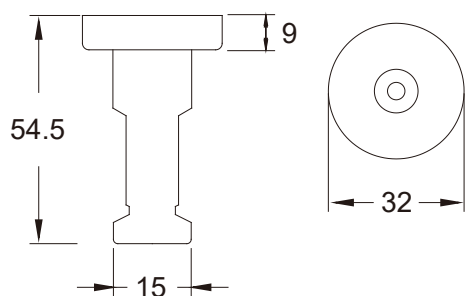

單位：mm

顏色：BK、SC、AB

663 BK 掛勾



尺寸：W39xH114mm 孔距：32mm

663 BSN 掛勾



尺寸：W39xH114mm 孔距：32mm

671 活動式掛勾(自動彈回)



顏色：BSN、BK
尺寸：W24xH55mm
孔距：16mm

Z634 掛勾



尺寸：W78xH150mm 孔距：32mm

Z627 掛勾



顏色：BK、SN
尺寸：W30xH90mm
孔距：74mm

Z650 掛勾



尺寸：W45xH44mm 孔距：16mm

664 茶花陶瓷掛勾



尺寸：W58 X H107mm

659-1 茶花陶瓷掛勾



尺寸：302 X 117mm

655-1 掛勾



尺寸：W52xH92mm

653-1 掛勾



尺寸：W76xH85mm 孔距：50mm

656-1 掛勾



尺寸：W57xH89mm

652 掛勾



尺寸：W100xH129mm 孔距：28mm

654-1 掛勾



尺寸：W53xH90mm

657 掛勾



尺寸：W60xH85mm

I10 油壓上掀撐桿



承受重量分為10kg、15kg、20kg，訂購時請註明

圖例



I12 上掀隨意停撐桿



承受重量8kg

圖例



I13 下掀緩降撐桿



承受重量8kg

圖例



I3046-1A 重型上掀撐桿



圖例



承載重量：3至15公斤(按照施工圖正確安裝可達隨意停效果)

I3049 重型上掀撐桿



圖例



承載重量：4至6公斤(按照施工圖正確安裝可達緩衝效果)

I632 分段式上掀撐桿(隨意停)



承受重量：6kg

圖例



I633 油壓上、下掀撐桿



左、右邊，承受重量：6kg

(附鉛框專用配件)

圖例

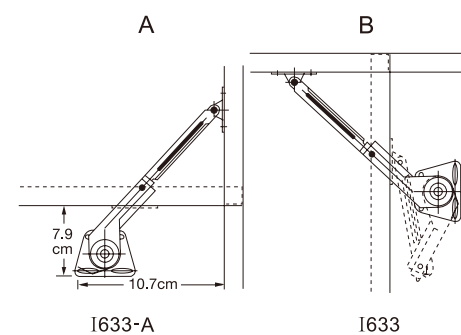

I633-A

I633

I16 塌塌米支撐器

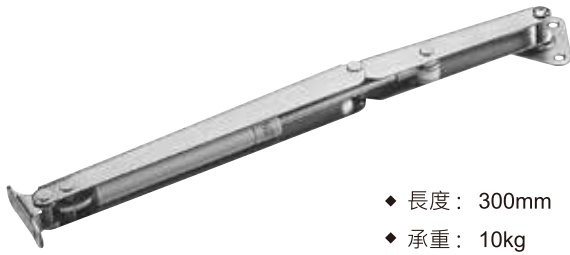

- ◆ 長度：300mm
- ◆ 承重：10kg

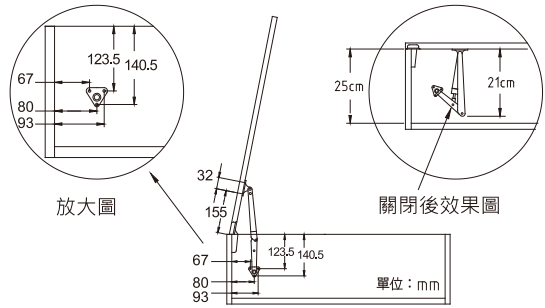

I3042 油壓上掀組合 (具緩衝功能)

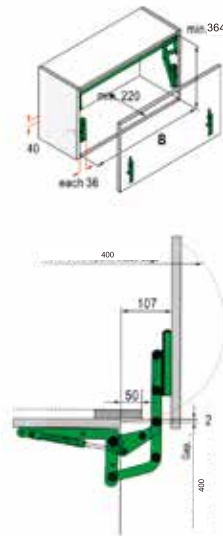

圖例



型號	櫃體實際寬度
I3042A	600~800mm
I3042B	800~1000mm

※ 門片固定高度40公分，櫃體實內深度23公分以上

I3041 油壓上掀組合

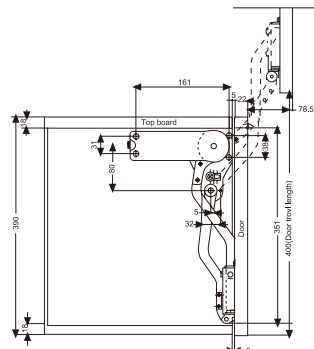

圖例



可微調承重壓力及門板高度，橫桿長度90、120cm兩種
可依實際門寬裁切橫桿長度

※ 門片固定高度40公分，櫃體實內深度19公分以上

I17 塌塌米支撐器



- ◆ 載重：15kg
- ◆ 材質：不銹鋼外殼



I3052 SUSPA 櫃體安全緩衝撐桿

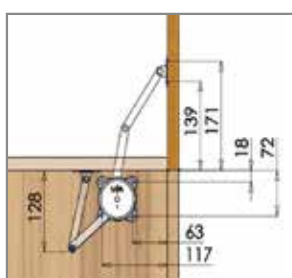

L926 隱藏式木質燙衣板



規 格：D440xW307xH150mm
 承 重：40kgs
 表面處理：鍍白鋅



L17B 多孔支架



材質：鐵 (Fe)
 表面處理：毛絲面 (BSN)
 承重：40kg

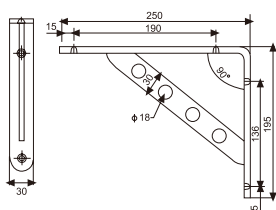

L18B H型支架



材質：鐵 (Fe)
 表面處理：毛絲面 (BSN)
 承重：40kg

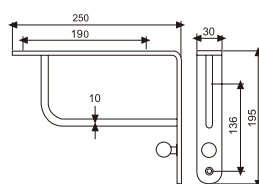

圖例



G0401~3
雙臂升降衣架



編號	櫃內可調寬度
G0401	520~670 mm
G0402	670~900 mm
G0403	900~1220 mm

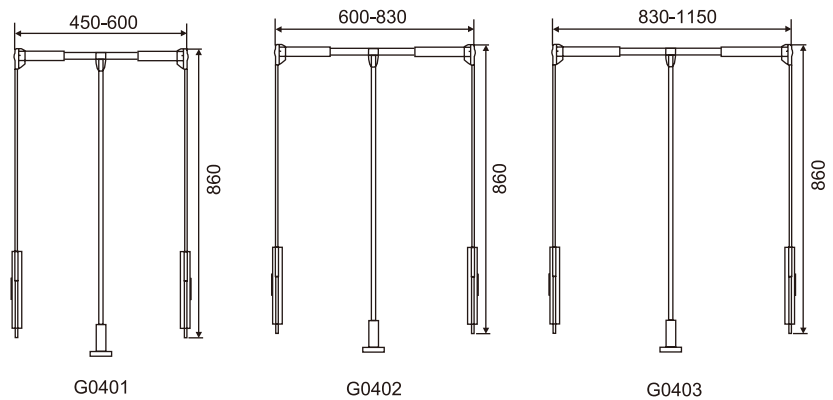

Y2028
伸縮鏡的配件

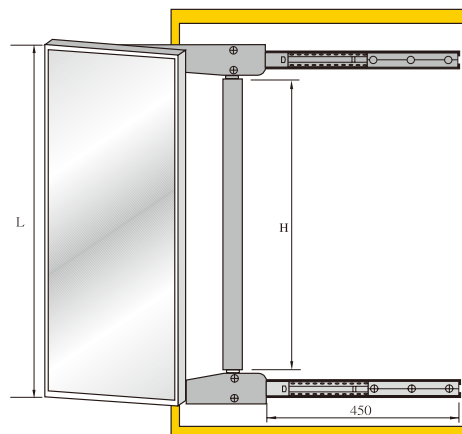

尺寸規格	H	L
A	75	88cm以上
B	120	130cm以上

顏色：黑色、白鋅色

※鏡子由衣櫃內抽出，並可任意旋轉，改善傳統固定式無法旋轉的缺失，以達人性化空間訴求。

L5033 活動雙面鏡



(正常, 放大3倍)

Y2027MIR 鋁框伸縮鏡組合



尺寸：

長1150x寬400x厚20mm，
櫃體深度至少500mm

功能：

安裝收藏於衣櫃中，可拉出
旋轉90°（有貼玻璃防爆膜）

※ 鋁框鏡高度可訂製，最大高度134cm

※ 「防爆膜」為防止玻璃破裂時碎片飛
散，並非指玻璃都不會破

L5017 360度旋轉鞋架（不含櫃體）



型號	規格(寬X深X高)	櫃內尺寸(帶門)
L5017-6	750x310x1010mm 6層	850x420x1010mm
L5017-10	750x310x1570mm 10層	850x420x1570mm

以上櫃內尺寸適合帶門的鞋櫃，如不帶門，請將深度減至400mm
360度雙面旋轉鞋架一樣的空間可達到最佳收納效果

L5004H 緩衝西褲架



L5004H80 76.4X48X7.5cm
L5004H90 86.4X48X7.5cm
(規格：寬X深X高)



L5005H 緩衝飾物架



L5005H80 76.4X48.5X7.5cm
L5005H90 86.4X48.5X7.5cm
(規格：寬X深X高)



L5008H 緩衝頂裝S型褲架



36X45.5X13.5cm
(規格：寬X深X高)



L5037H 緩衝側裝多功能活動西褲架



40X45.5X22cm
(規格：寬X深X高)



L5009H 緩衝頂裝掛衣架

12X46.7X14cm
(規格：寬X深X高)



L5036H 緩衝頂裝雙排西褲架

65X45.5X13.5cm
(規格：寬X深X高)



L5035H 緩衝多功能西褲架

L5035H80 76.4X47X13.5cm
L5035H90 86.4X47X13.5cm
(規格：寬X深X高)



L5039 高櫃旋轉多功能組架

特色: 完全利用衣櫥角落收納
每一層可360°獨立旋轉
方便拿衣物，美觀、實用
安裝簡易、結構穩固、收納
吊掛各式衣物，都沒問題唷！



櫃內 76.4X76.4X190~210cm
(規格：寬X深X高)



L5038 360° 三層轉盤



71X71X93.5 cm
(規格：寬X深X高)



L03B 四邊籃 (加配件可成三邊籃)



J3056 滑軌式電腦鍵盤架



L5081 置物架



L908 活動褲架



A637 簡便型領帶架



A638 攜帶型鋁衣架



L5041 按開式掛衣架



◆單位：mm 高：23mm



(按開前)



(按開後)

L5019 360度吸頂旋轉掛衣架



L5019
600x600x190mm
(規格:寬X深X高)

L5018 360度雙層可調旋轉掛衣架



L5018
680x680x1300mm
(規格:寬X深X高)

高度調節範圍
1300~2400mm

L5015 領帶架



90X460X90mm
(規格：寬X深X高)

L5034 迷你皮帶架



156X156X121mm
(規格：寬X深X高)

L19B 活動式吊掛架

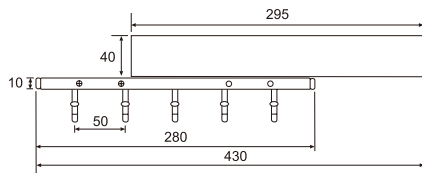

L20B 活動式領帶架

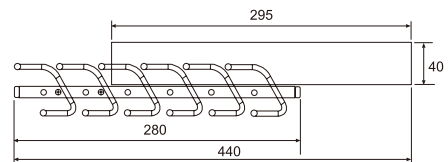

L12B 領帶架+小托盤(領帶夾插槽設計)

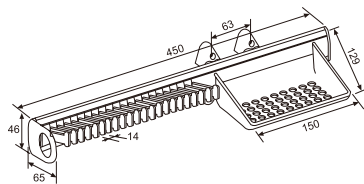

L11B 領帶架

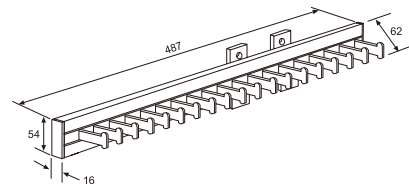
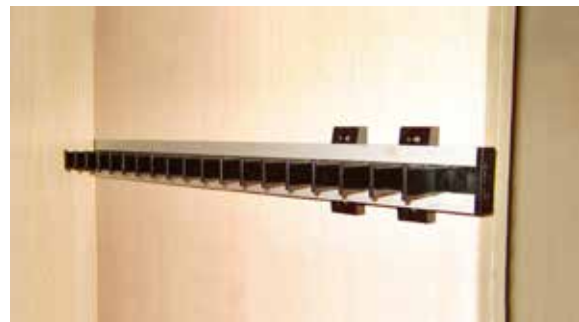

L05B 領帶架

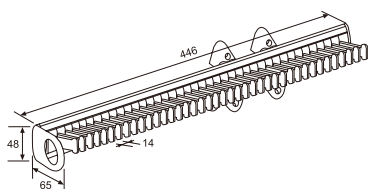

L13B 領帶架(皮帶架)

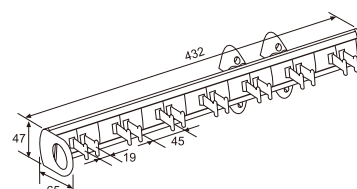

L07B 試衣架



長度 30、35、40 cm



L16B 試衣架



長度 25、35、45 cm



L922 櫃內垃圾桶



尺寸：H40×W26×D35cm

圖例



L927 鞋架

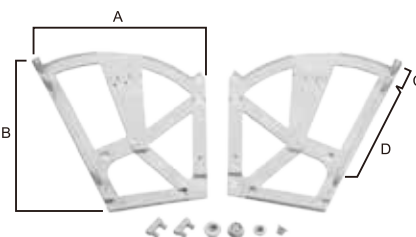

規格	尺寸	A	B	C	D
雙層鞋架		200	258	32	160



L14WT 活動折合支架



圖示



L14WT10	10"	253*188mm
L14WT12	12"	303*188mm
L14WT14	14"	353*188mm
L14WT18	18"	450*260mm

包裝：2支/組
(適用1000pcs訂製品)

● B20 頂天立地組合系列



沙伯迪奧

展示架、掛衣架、衣櫥、屏風、置物架
都是頂天立地可以組合變化而來的



B20 立柱
(50X50mm)

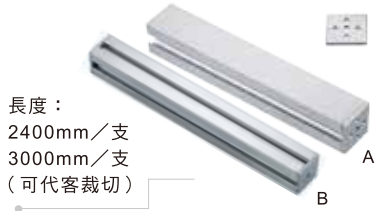

B20S 立柱
(30X55mm)

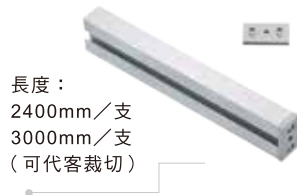

B24 層板封邊條

長度可依客戶需求訂製



B22 L型連桿



B21 直型連桿



B23 L型支座



B2312 L型層板支座



B2312-1 L型玻璃支座



L618-1 O型管 (吊衣桿)



B21A 直型連桿結合器

側邊補強用



B23A L型支座結合器



B26 桶身結合器 (六分板)



L619-F 吊衣桿結合器



B2312A L型層板、玻璃結合器



B27 腳座





EhShine

B13 重型壁板配件組合系列



B13-2 軌道規格圖

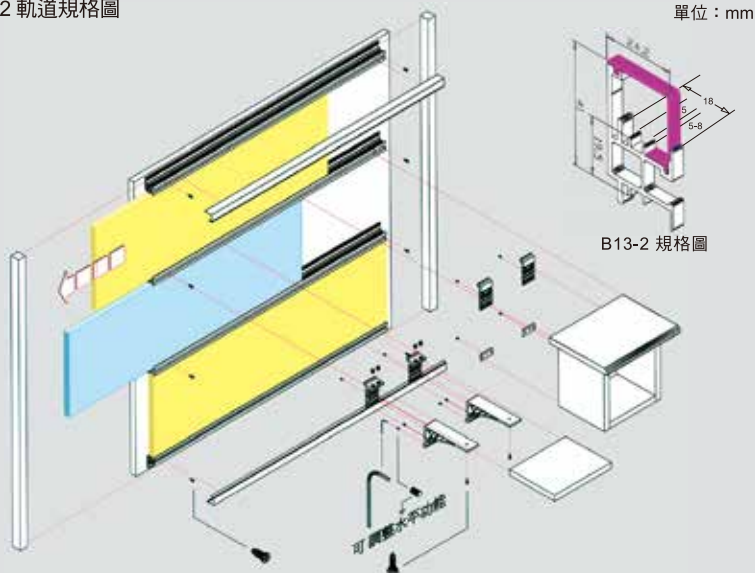

- ▲ B13層板支撐架：可承載深度25~30cm各式5mm玻璃或18mm及25mm木板，利用卡合功能，使各式層板均能穩固。（具水平調整功能）
- ▲ B17櫃體吊掛五金組：可吊各式櫃體類。（具水平調整功能）
- ▲ B13-1上下修飾蓋：於整體施作完成後，讓整組壁板系列上下均能完整修飾。
- ▲ B13-2壁掛區隔條：可裝置5~8mm玻璃（如為噴砂或清玻璃，應於後面加5mm內素色背板），12mm或18mm木板類，讓空間變化更多元。

專利號碼：M257384

B13 層板玻璃支撐架



尺寸：155X40mm

B13-1 上下修飾蓋



尺寸：3米/支（可代客裁切）

B13-2 壁掛區隔條



尺寸：3米/支（可代客裁切）

B13-3 壁板用單鉤



B13-4 層板鋁片架



深度：153mm 長度可訂製

B13-6 衣架掛鉤



尺寸：155、205 mm

B13-8 8mm玻璃支撐架



尺寸：102x40mm

B17-1(下墊片)



B17 櫃體吊掛配件(上結合器)



尺寸：40X70mm

Z634-1 壁板用衣鉤



B13-9掛壁鋁片(A047/B13-6用)



J3070 CD架(搭配B13-3)



長度可訂製

B5 輕型壁板組合系列 (正面嵌入)

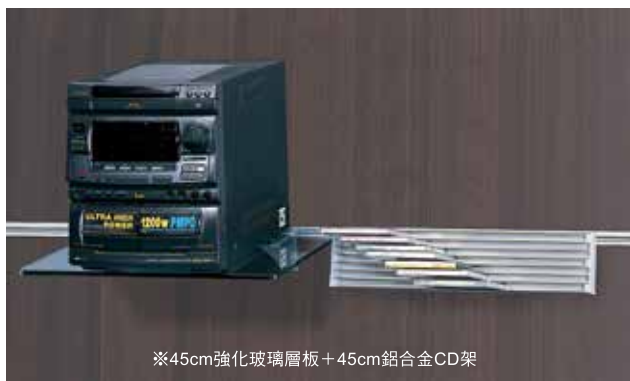

※可當壁板修飾條裝飾用

組合式CD·音響架分解圖

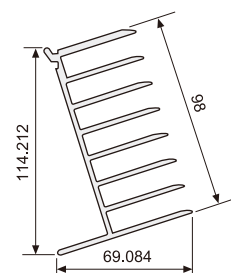
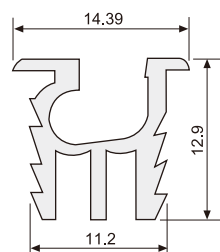
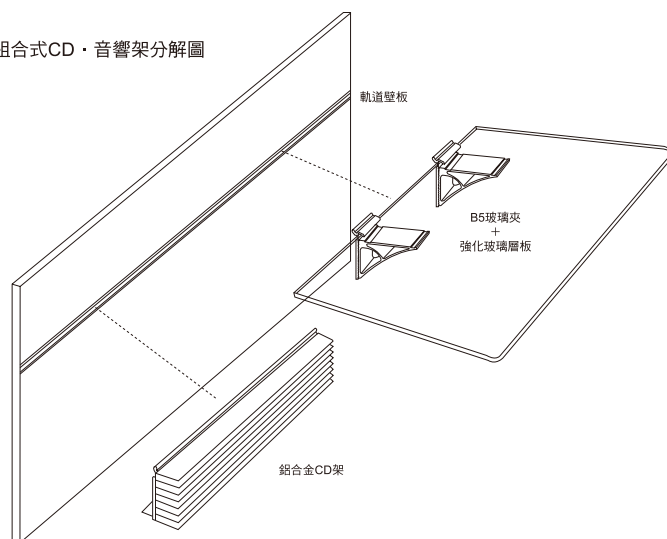

※ 施工方式：

軌道正面嵌入，嵌入前先行注入矽利康於木板溝槽，以利加強結構。

B5 軌道配件



B5 玻璃夾配件



尺寸:96x35mm
可夾厚度30mm

B5 掛鉤



B5 後座配件



木螺絲或無

B5 CD架配件



長度可訂製

K3506 木質地板上掀組合五金

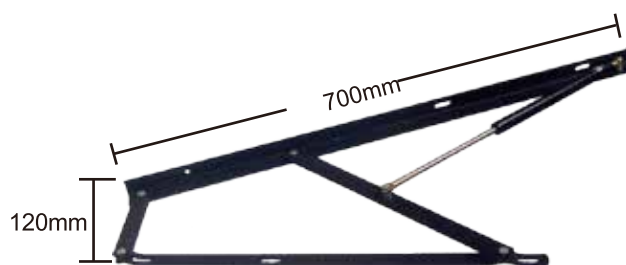
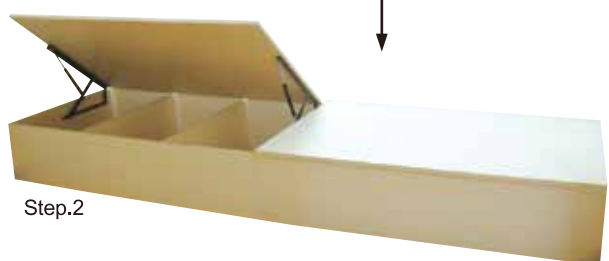

氣壓棒規格：15kg、20kg、25kg



K3501 排骨床架



雙排床架 3.5尺X6尺2、5尺X6尺2、6尺X6尺2、6尺X7尺，高度24.3cm

K3505A 餐台隱形床架五金



床架規格：3.5尺x6尺2



(不含板材)

K3504 上掀式排骨床架



床架規格：5尺X6尺2、6尺X6尺2 氣壓棒規格：90Kg、100Kg

K2306 新型掀床五金組

專利案號：094216565



支架主體

氣壓棒

附帶螺絲



床架規格	氣壓棒
3.5尺X6.2尺	60Kg
5尺X6.2尺	90Kg
6尺X6.2尺	90Kg
6尺X7尺	100Kg

※氣壓棒規格：60kg、80kg、90kg、100kg，訂購時請註明

EBED 電動床架+進口主機+乳膠床墊



床架規格：900x1870x290mm
 進口主機：歐洲制德國進口馬達
 乳膠床墊規格：900x1870x290mm 75D.85D

EBED-Z 電動床架+進口主機



床架規格：900x1870x290mm
 進口主機：歐洲制德國進口馬達

K2906 床頭連接器



K2914 床架補強角碼



尺寸：長235x寬70x高35

K2305 床頭調整支架



尺寸：行程50、120mm

K3510 折疊凳五金

- 1.載重：100kg
- 2.材質：鐵烤漆
- 3.可結合於鞋櫃、牆面等應用貼心的設計。
- 4.方便人們穿鞋時的起坐，清潔地面時凳子更不用搬來搬去，隨時拉出即可當成凳子使用。

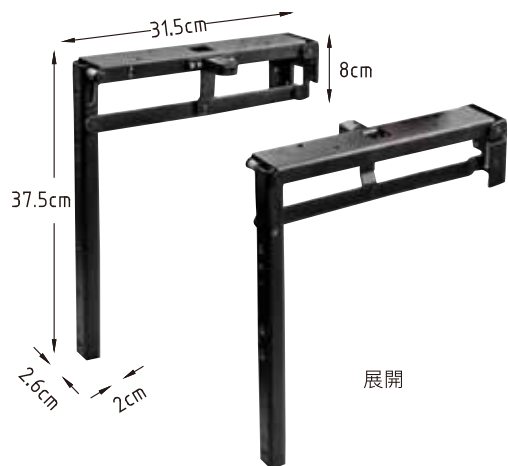

範例一 可結合於鞋櫃家具設計



範例二 可結合於牆面一體設計



時尚收納椅
實用
不佔走道空間

H1001 重型折疊門

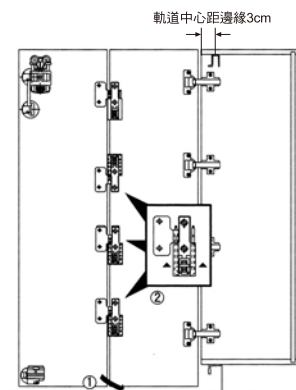

特性：推拉輕盈、耐重、穩定性高
下軌輪可不需安裝



軌道參考：P.161

軌道：3米長

HM3502 上(側)抽門滑軌



- 1.長度：40cm、45cm
- 2.安裝：側面安裝需加連桿以保持平行滑動同步。
- 3.承重：9Kg/45cm(18")
- 4.優點：靜音滑軌，回彈定位，防滑出保護件。
- 5 附加配件：橫桿x1，固定輪軸x2，鉸鏈x2 (吋35，蓋3分)

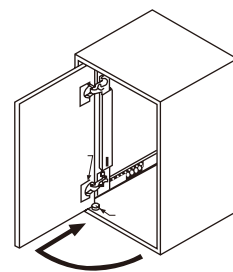

K014 外掛式躺門組合(不可調水平)



1. 材質：鐵質（耐重考量）
 2. 適用門厚：18~40mm
 3. 載重：50Kg
 4. 顏色：時尚銀
- 軌道圖請參考第161頁
專利申請案號：094205535

二門：內門x1 外門x1
三門：內門x2 外門x1

K035 矮櫃外掛趟門配件

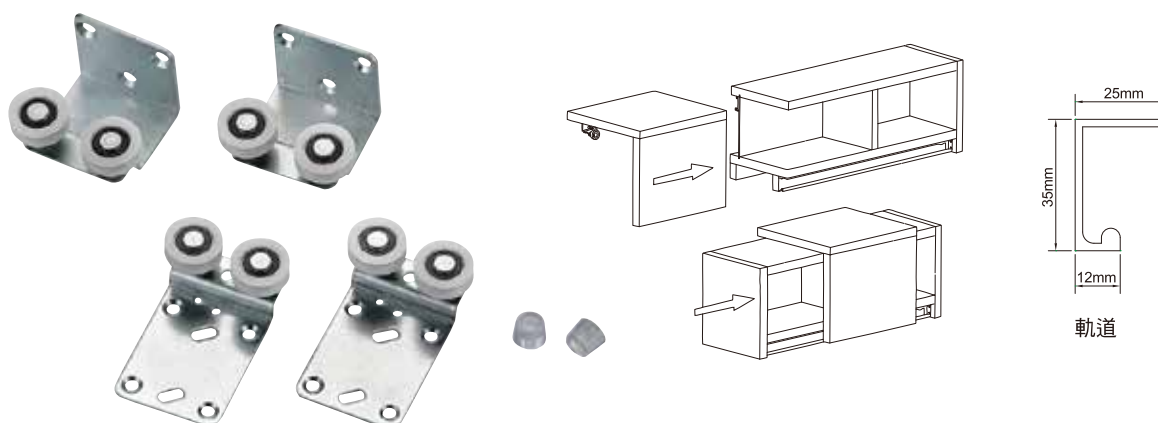

K036 書櫃外掛趟門配件

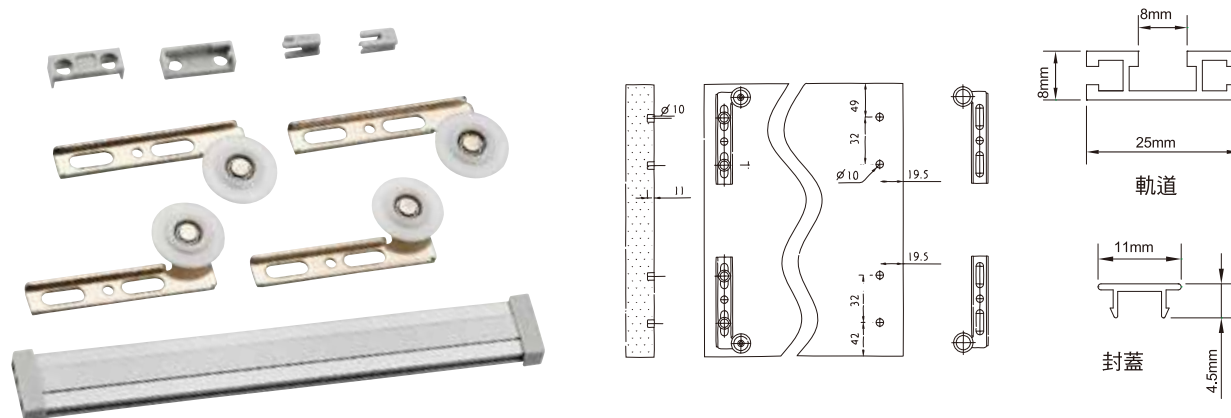

K017B 吊輪推門配件



1. 簡易安裝法

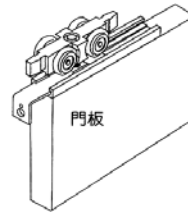

2. 隱藏式安裝法

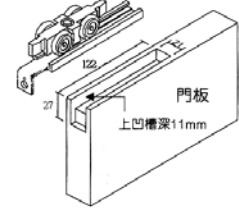

下門止施工法

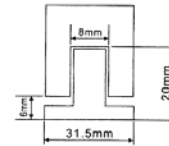

軌道圖請參考第152頁 K017A

K021 吊輪推門配件



1. 簡易安裝法

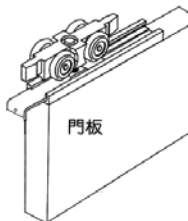

2. 隱藏式安裝法

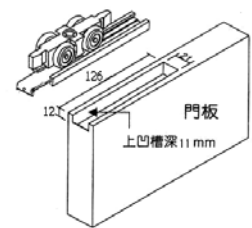

下門止施工法

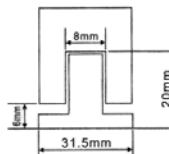

軌道圖請參考第152頁 K017A

K038 吊輪推門配件(快拆型)



軌道圖請參考第152頁 K017A

K039 吊輪推門配件(快拆型)

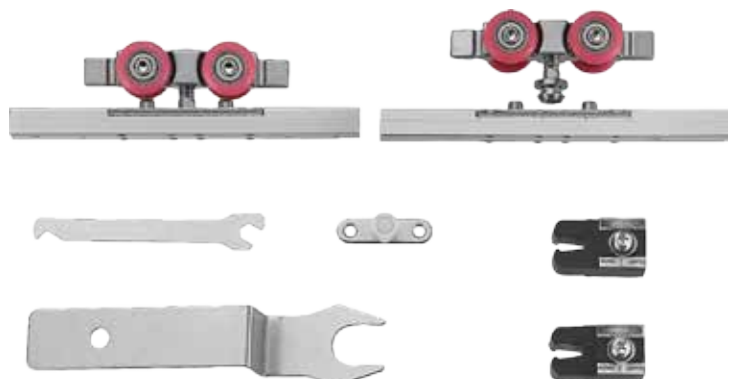

軌道圖請參考第152頁 K017A

K004 推門滑輪組

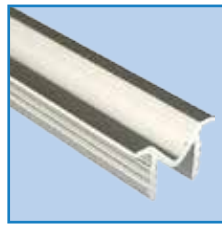
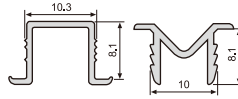
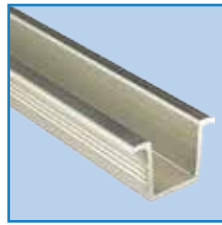

K005-1C 推門滑輪組

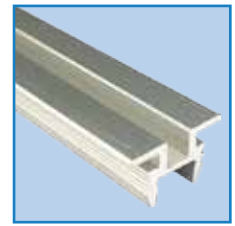
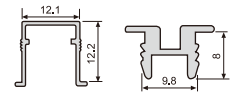
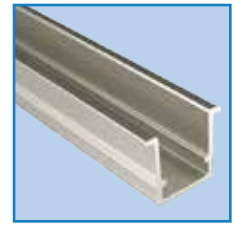

K005 新型推門滑輪組

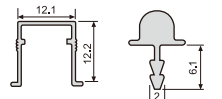
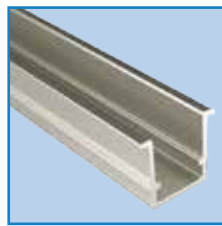

軌道顏色：SC
特性：行進中輕、靜、順暢，耐重性佳

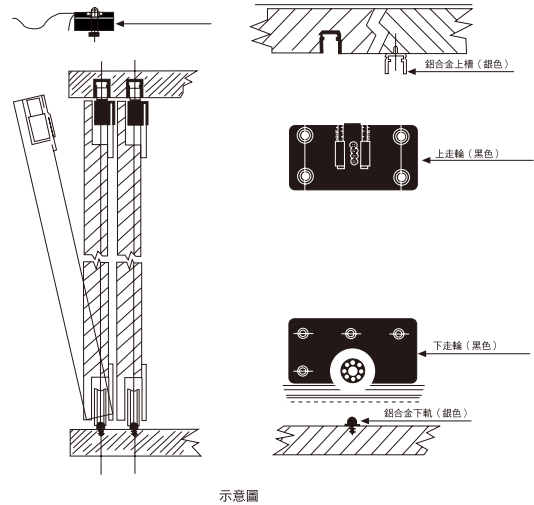

K011 內掛式躺門組合



以上適用門片2門及3門，下單時請註明
軌道分為8分~1吋板用，訂購時請註明板厚
軌道圖請參考第161頁

A051 櫃內LED層板燈條

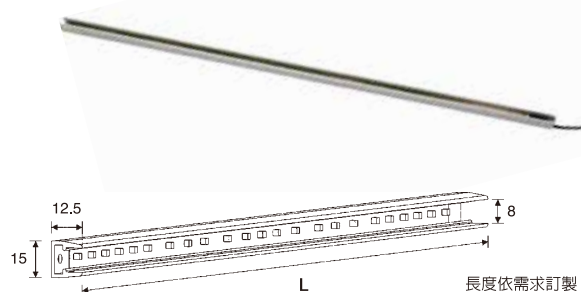

適用範圍：裝璜裝飾，櫃內玻璃層板及照明用途。(適用8m/m玻璃)
 電源電壓：DC12V(110V需配合KT6013變壓器使用)
 功 率：約2.5W/60公分
 特 點：※燈光透過玻璃照射出來柔和有質感。
 ※可使用雙面膠固定燈條，安裝簡便。
 ※長度可依客戶需求訂製。



A048 LED玻璃層板燈



適用範圍：外掛玻璃層板，櫃內玻璃層板及照明用途。(適用8-10m/m玻璃)
 電源電壓：DC12V(110V需配合KT6013變壓器使用)
 功 率：約2.5W/60公分
 光 源：LED節能環保，光源壽命長，不易發熱。
 特 點：※ 燈光透過玻璃照射出來柔和有質感。 ※ 長度可依客戶需求訂製。
 ※ 安裝方式，螺絲直接與主體固定於牆壁，安裝簡便。 ※ 電源開關可選配外接觸動開關(TP01A)於鋁主體表面上即可。

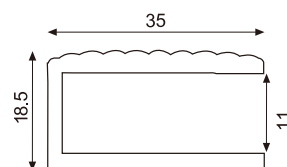

A052 LED隱藏式把手



適用範圍：廚具、廚櫃、家具、裝璜及照明用途。
 電源電壓：DC12V(110V需配合KT6013變壓器使用)
 功 率：約2.5W/60公分
 光 源：LED節能環保，光源壽命長，不易發熱。
 尺 寸：H59m/mXD30m/m，長度可依需求訂製。
 特 點：※ 獨特創新的設計感，不一樣的新感受。
 ※ 可當裝飾及隱藏式手把用途。
 ※ 長度可依客戶需求訂製，L片雙邊固定安裝容易。



圖例

A047 櫃體底板燈 (可量身訂做)



特色：

- 1.規格長、寬 (量身訂做)。
- 2.背板直接放置於底板燈玻璃上方，安裝便利。
- 3.可客製手掃式開關。

- ※寬度、深度可訂製
A. 可用LED燈管或T5螢光燈管
B. 施工方式：螺絲由側邊鎖入櫃體側板
 (白光、黃光，訂購時請註明)

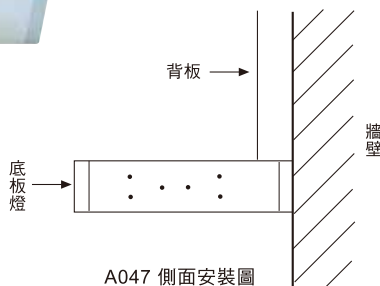

圖例



A047-1 櫃體底板燈 (可量身訂做)



特色：

- 1.規格長、寬 (量身訂做)。
- 2.背板左右修角邊後，插入底板燈溝槽，使產品增加美觀性及層次感。
- 3.可客製手掃式開關。

- ※寬度、深度可訂製
A. 可用LED燈管或T5螢光燈管
B. 施工方式：螺絲由側邊鎖入櫃體側板
 (白光、黃光，訂購時請註明)

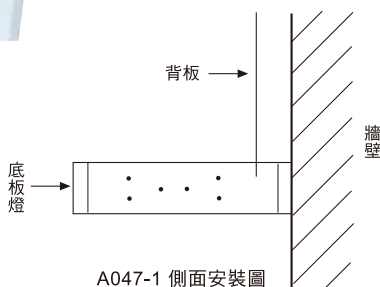

圖例



A047 層板燈 (可量身訂做)



特色：

- 1.規格長、寬 (量身訂做)。
- 2.螺絲直接與主體固定於牆壁，安裝便利。
- 3.可客製手掃式開關。

- ※寬度、深度可訂製
A. 可用LED燈管或T5螢光燈管
B. 施工方式：內附喜得螺絲直接與主體固定於牆壁
 (白光、黃光，訂購時請註明)

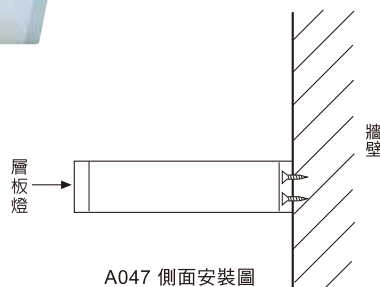

圖例



A053 弧型底板燈 (門片可免裝把手)



特色：

1. 規格長、寬 (量身訂做)。
2. 弧型設計，櫥櫃門片可免裝把手。
3. 可客製手掃式開關。

※寬度、深度可訂製

- A. 可用LED燈管或T5螢光燈管
- B. 施工方式：螺絲由側邊鎖入櫃體側板
(白光、黃光，訂購時請註明)

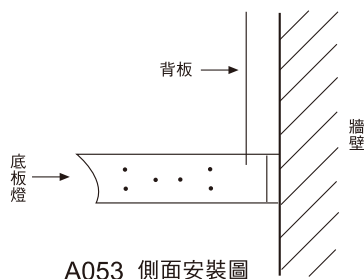

A053 側面安裝圖



圖例

A047BK-1 層板燈 (可量身訂做)

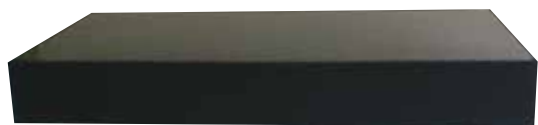

霧黑主體+黑噴砂玻璃

A047BK-2 層板燈 (可量身訂做)

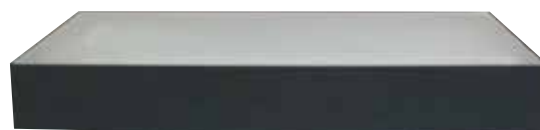

霧黑主體+噴砂玻璃

A046 T5 電燈組



光源：白光、黃光
T5 110V 尺寸：30.7cm / 56.7cm / 86.7cm / 116.7cm

A050 LED燈條



12V 光源：白光、黃光 尺寸可依客戶需求訂製 (需搭配KT6013變壓器)

A054 LED燈

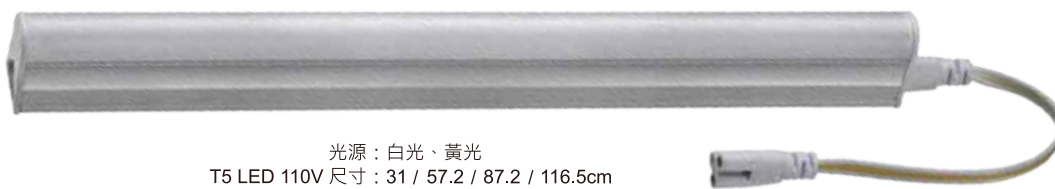

光源：白光、黃光
T5 LED 110V 尺寸：31 / 57.2 / 87.2 / 116.5cm

A034-1



12V 20W內含變壓器，電源開關

A011-1

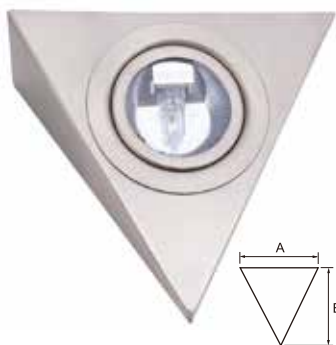

12V 20W (變壓器另購)
A:128mm B:143mm

A011-2

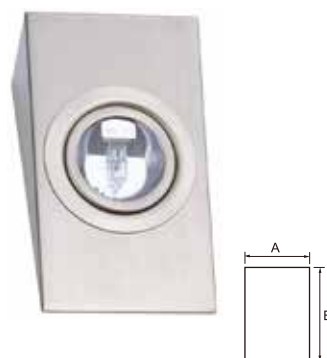

12V 20W (變壓器另購)
A:81mm B:151mm

A025 嵌燈



開65mm孔
110V 50W 顏色: PC
(免變壓器)

A011



開60mm孔
12V 20W (變壓器另購)

A014



正面鎖不用開孔
12V 20W (變壓器另購)

A042 LED 嵌燈



說明：
1Watt LED壽命長達10萬小時，光度可達25~30流明，壽命長達10萬小時。

A057 LED 燈(免用變壓器)



燈殼顏色: SC、BK
正面鎖不用開孔, ϕ 45
白光 (6000K)、自然光 (4000K)
LED 2W 電壓: 110-220V 共用、H=8mm

KT6011A 變壓器



適用：鹵素燈具

60W變壓器

TP01A 觸動開關



二段式碰觸開關

150W 120VAC

TP99 電燈開關



外徑 \varnothing 22mm 內嵌 \varnothing 20mm

TP05 微動開關



適用：門片對開、抽屜

TP10 德製微動開關



適用：門片對開、推拉門、衣桿燈、抽屜

TP09 微動開關



適用：門片對開、推拉門、衣桿燈、抽屜

KT6013 LED專用變壓器



AC115 / DC12V 27W

TP07 電燈開關



TP08 快速接頭



A010 鹵素燈珠



12V 20W

TP11P LED 電燈開關



規格：5PIN

尺寸：長2.6cm 寬2.1cm 高1.4cm

TP11A LED 觸控迷你開關

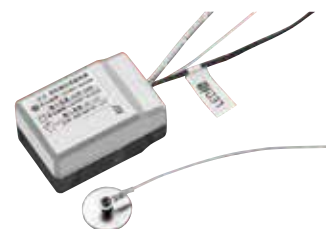

二段式觸碰開關

60W 110-220V

KS9017 鋁斜吧台支撐器

KS9016 斜吧台支撐器

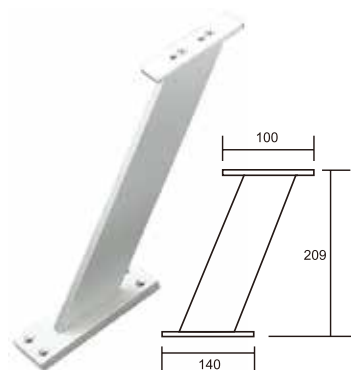

圖例



圖例



可適用木板及玻璃

J3067 CD架



尺寸319X159mm

J3064 CD架



尺寸34X355mm

J3063 CD架



尺寸221X112mm

J3070 CD架



長度可訂製

安裝圖例

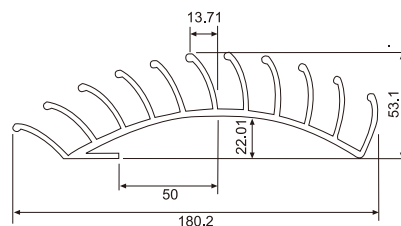

L9011-6 旋轉系列 (200)



適用100pcs訂製品

L9011-5 旋轉系列 (400)

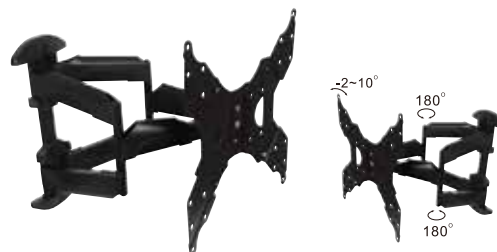

適用100pcs訂製品

L9011-1 (角度不可調)

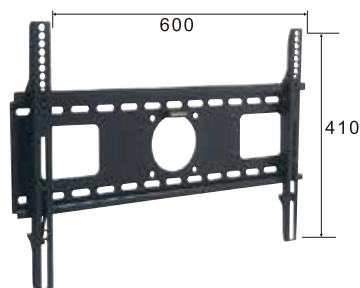

適用100pcs訂製品

L9011 (角度可調)

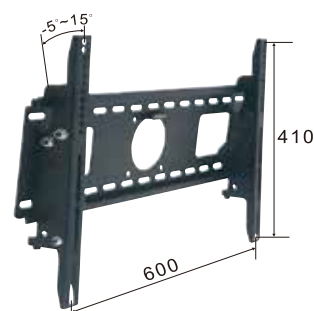

適用100pcs訂製品

L9011-4 (角度不可調)



L9011-2 (角度不可調)

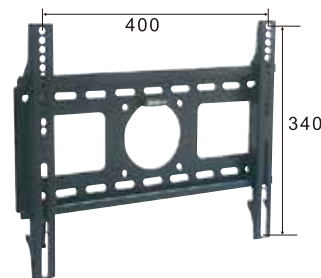

J3090-3 門檔

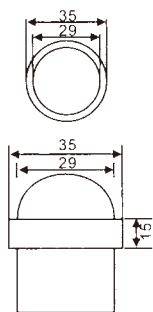

材質：#202



J3088 門檔

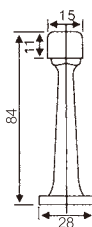

材質：鋅合金



J3090-1 門檔

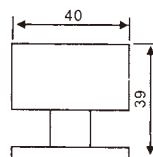

材質：#202



J3092-1 門檔

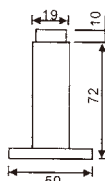

材質：#202



J3090-2 門檔

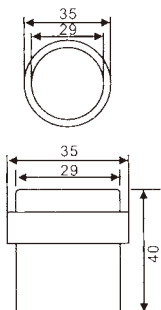

材質：#202



J3092-2 門檔



材質：#202



J3093 門檔

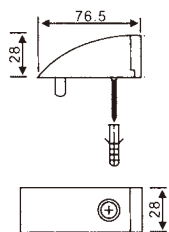

材質：鋅合金



J3091 門檔

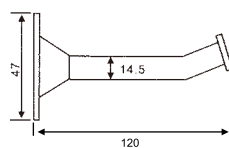

材質：鋅合金



J3089-1 半圓門檔+磁吸

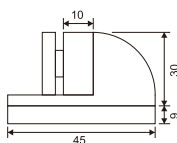

材質：鋅合金



J3089 半圓門檔

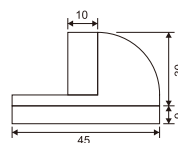

材質：鋅合金



J3087 門檔

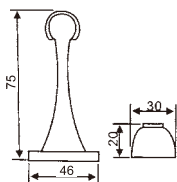

材質：#202



J3094 門檔

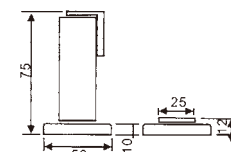

材質：#202



662-2 衣勾

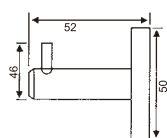

材質：#202



EC077 鋁合金掛勾

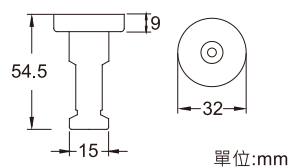

顏色：BK、SC、AB



662-3 衣勾

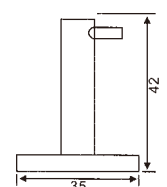

材質：#202



662-1 衣勾

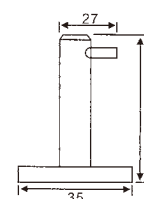

材質：#202



K2921-2 圓形鎖

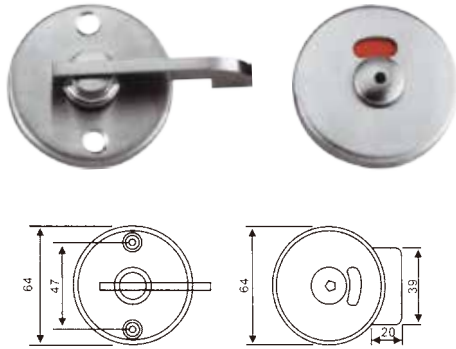

材質：#202
適用板厚：10~12mm

K2921-1 圓形鎖

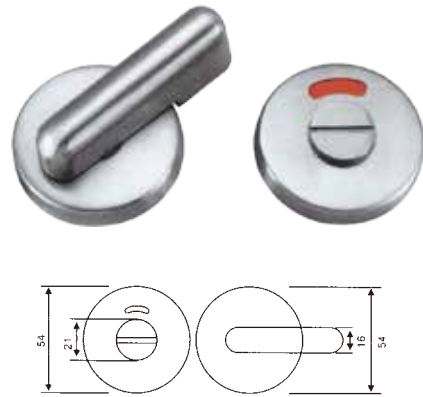

材質：#202
適用板厚：10~12mm

K2920 門栓

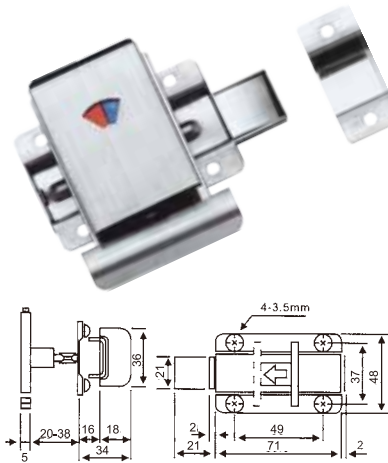

材質：#202

K2919 門栓

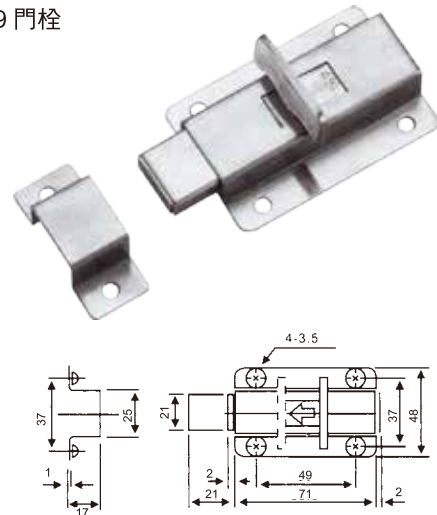

材質：#202

K2926 防盜鍊

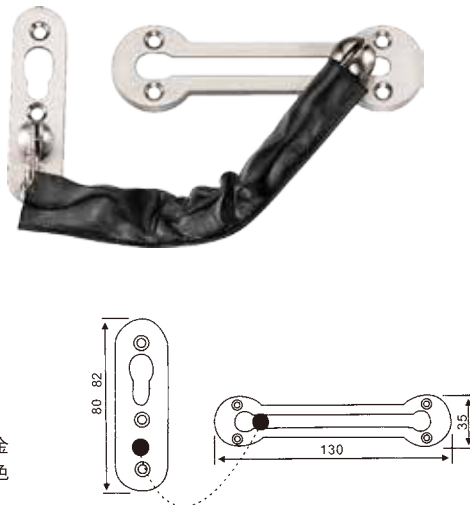

材質：鋅合金
顏色：鍍刷色

K2925 防盜鍊

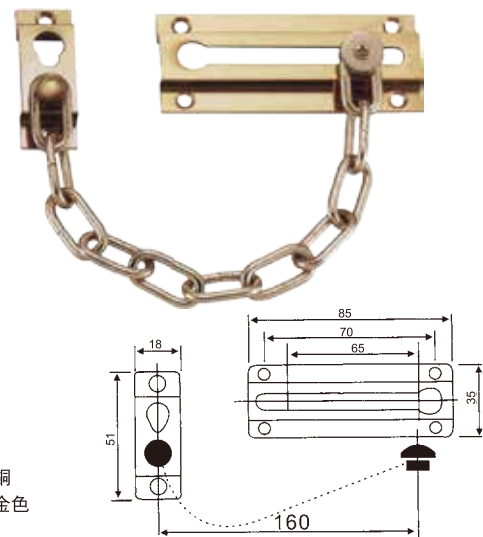

材質：銅
顏色：金色

K2918-6" 門栓



材質：#202

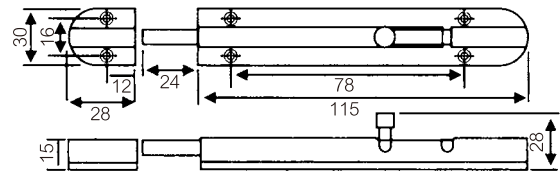

K2917-6" 天地栓



材質：#202

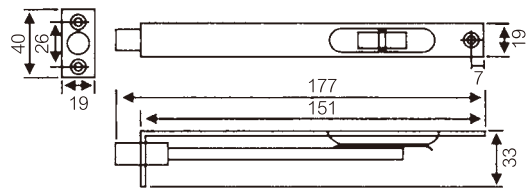

K2923 防塵塞



材質：鋅合金

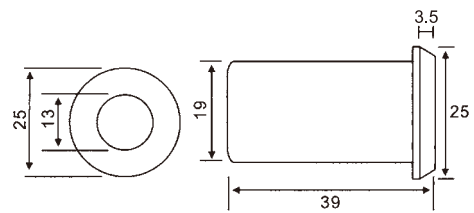

K2922-1 銅彈珠鎖



正面

側面

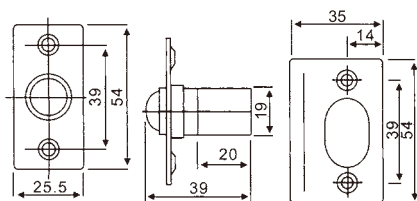

材質：銅

K2922-2 鋼彈珠鎖



側面

正面

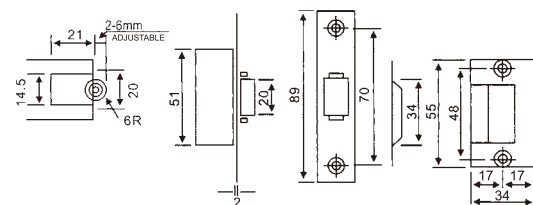

材質：#202

K2928-1 圓盤拉手

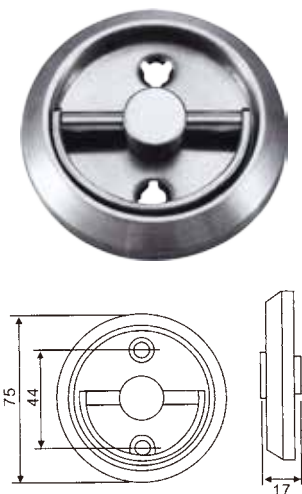

材質：#202

K2928-2 圓盤拉手

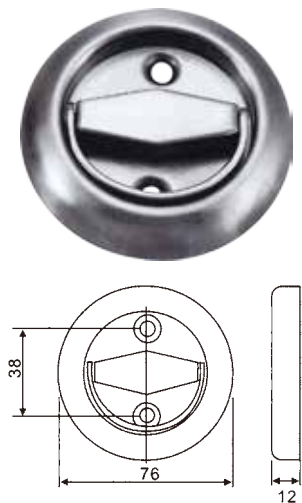

材質：#202

K2927 旋轉鉸鍊



材質：銅

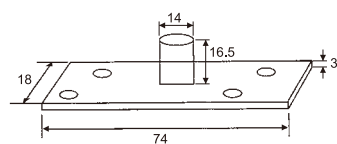

K2924 安全門扣



材質：#202

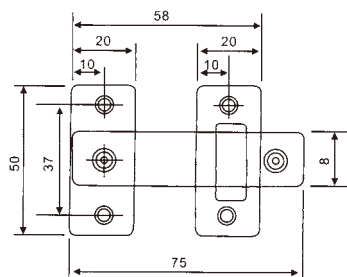

K2929 安全門扣



材質：鋅合金
顏色：水霧鉻
鉻色
紅古銅

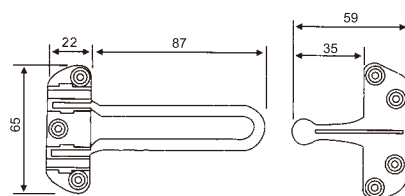

J3077B 轉盤



尺寸：20.3、30.4、44.2、50.6、60cm

J3058 轉盤



A：尺寸有33、39、48、60、80cm
B：尺寸有23、30、35、40、45、50、60cm

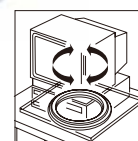

C11 抽屜鎖



適用：18m/m~21m/m板厚，孔徑：19m/m

J3057 轉盤



150mmX210mm

658 快拆型吊圖鋼索掛勾 (5尺)

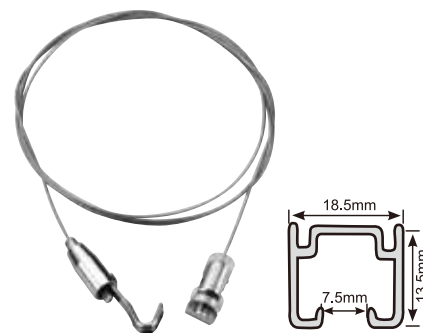

軌道：3米長

605-A



左、右邊

605-B



左、右邊

605-C



左、右邊

J3084 不鏽鋼信箱蓋



尺寸：W340xH76xD8m/m
表面處理：毛絲面(BSN)

K2911 桌腳結合器



I3035



AE636 鏡珠



可另購牙節螺絲：長度25、35、50、63、74mm

E636 鏡珠



可另購牙節螺絲：長度25、35、50、63、74mm

AE639 飾片



AE636 鏡珠蓋



E658 飾片, 鏡珠蓋兩用



Z638 飾片



B16 玻璃透明墊片

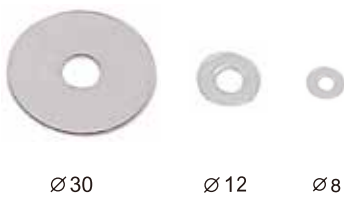

660 隱藏式掛鉤

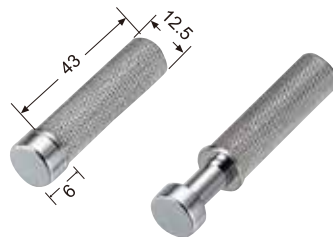

M3083 軌道式層板裝置

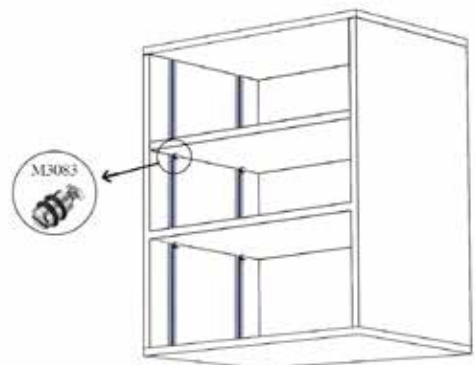
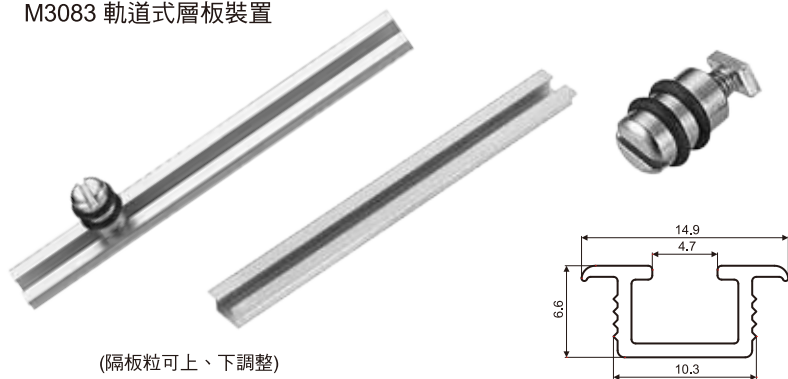

669 重型、反彈式拍門器



原始總長 85mm
展開總長 120mm

670 反彈式、拍門器+磁吸



原始總長 80mm
展開總長 120mm

B1 玻璃夾



可夾厚度達18mm
顏色：BSN、PC、SC、GWT
孔距：12mm

B4 玻璃夾



可夾厚度達27mm
顏色：GSC、GWT
孔距：72~76mm

B6 玻璃夾



可夾厚度達8mm玻璃
孔距：36mm

B7 玻璃夾



可夾厚度達10mm玻璃
孔距：32mm

B8 KD玻璃夾



Ø 5mm
可夾厚度達5~6mm

B9 KD玻璃夾 (固定式)



Ø 5mm
可夾厚度達5~6mm

M3079 玻璃夾



可夾厚度達6~10mm

K2915 吊廚固定器



左、右邊/組

B32 透明墊片



Ø21mm 厚度3mm

B14 透明墊片



Ø8mm 厚度2.5mm

B29 透明墊片



Ø10mm 厚度2mm

B30 透明墊片



Ø12mm 厚度4mm

651 彈壓式拍門器



顏色：灰、白
 只要配合一般鉸鏈按壓後即可使門片彈出，
 適用於無把手設計，簡易安裝，可微調門縫間隙

651-1 彈壓式拍門器 + 磁吸



顏色：灰、白
 簡易安裝，可微調門縫間隙並有磁鐵吸附門片功能

610 甲蟲吸 (拍門器)

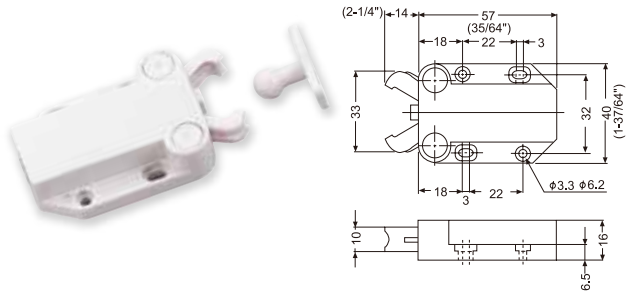

603 拍門器

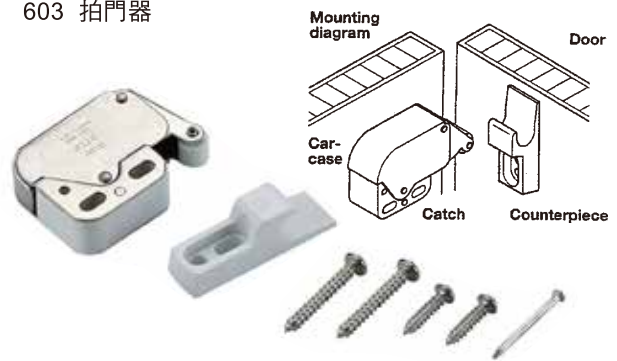

601 磁吸



661 薄磁吸

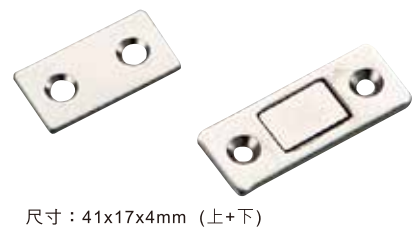

拍拍手 (玻璃門拍門器)



ES 緩衝器



ES-01 緩衝器

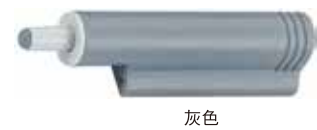

圖例



A629 鋁透氣孔

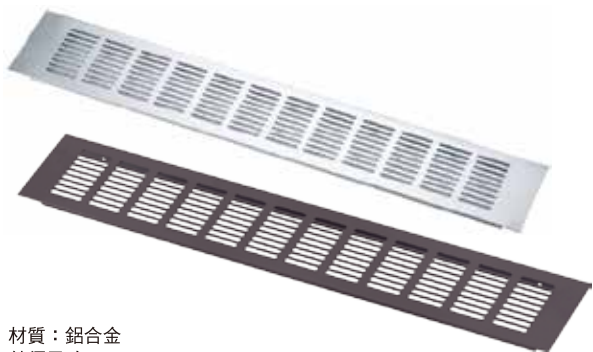

材質：鋁合金
外徑尺寸：150X80、300X80、500X80mm
顏色：SC、BK

A665 鋁透氣孔

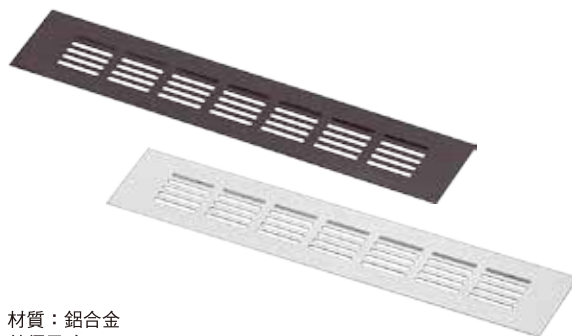

材質：鋁合金
外徑尺寸：150X50、300X50、500X50mm
顏色：SC、BK

J3096 鋁出線盒



材質：鋁合金
外徑尺寸：80x80、160x80、300x80mm

P642 塑膠透氣孔



材質：塑膠
尺寸：219X60mm

ST628 透氣孔(不鏽鋼)



材質：不鏽鋼
外徑 \varnothing 60mm，內徑 \varnothing 53mm

J3051 鋁出線盒



材質：鋁合金
外徑 \varnothing 61mm，內徑 \varnothing 54mm
顏色：SC、GBK

J3095 雙邊出線盒

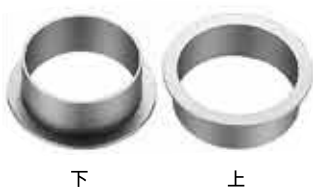

材質：鋅合金
外徑 \varnothing 62mm，內徑 \varnothing 52mm
適用板厚：18mm

J3073 小圓徑出線盒



材質：塑膠
外徑 \varnothing 44mm，內徑 \varnothing 35mm

J3074 新型出線盒



材質：ABS塑料
外徑 \varnothing 68mm，內徑 \varnothing 60mm

J3075 出線盒



材質：塑膠
外徑 \varnothing 63mm，內徑 \varnothing 53mm

J3086 出線盒



花梨

胡桃

白橡

材質：塑膠 外徑 \varnothing 66mm，內徑 \varnothing 55mm

J3085 出線盒



淺灰

土黃

黑

白

材質：塑膠 外徑 \varnothing 70mm，內徑 \varnothing 60mm

D07 補強角碼



100pcs/包，尺寸19X19X30mm

G04 補強角碼



200pcs/包，尺寸61X61X15mm

K2909 補強角碼



尺寸35X35X35mm

G03 補強角碼



100pcs/包，尺寸39X39X17mm

ZL622 桌角飾片



A. H5.2X44X44mm
B. H8X76X76mm

K015 培林輪



外徑：22 mm

K037-2 T型導輪



尺寸：L=42 W=15 H=21mm Ø12mm

K037-3 T型導輪



尺寸：L=50 W=18 H=16mm Ø16mm

K037-4 L型導輪



尺寸：W=41 D=33 H=61mm Ø12mm

K037-1 T型導輪



尺寸：L=48 W=12 H=12mm Ø7.5mm

O型管 (吊衣桿)



L613 鐵質鍍鉻

618 鋁合金
顏色：SC、GBK

尺寸圖可參考第160頁

M3078 隔板粒



5m/m插銷

M3076 玻璃隔板粒



AB

SN

5m/m插銷

M3084 玻璃隔板粒



3m/m插銷

M3077 隔板粒



A
透明
5m/m插銷



B
白色
5m/m插銷



C
透明
3m/m插銷

Q18 層板粒



Q18-1



Q18-2



Q18-3



Q18-4



Q18-5 6mm
Q18-5A 8.5mm

顏色:銅色、鍍色

L619-A 目玉



銀色



鍍色



黑色

L668 衣桿固定器



亮鍍色(PC)



霧鍍色(SC)

示意圖



L648

L648-1



顏色:黑色、鍍色



顏色:黑色、鍍色

高70x寬50(固定高度)

新型懸吊式衣桿托



L622

H 80-105mm



L622-1

H 80-105mm



L623

H 85-110mm



L623-1

H 85-110mm

※特色：本系列產品可調整高度 顏色:鍍色

L644 隱藏式層板支架

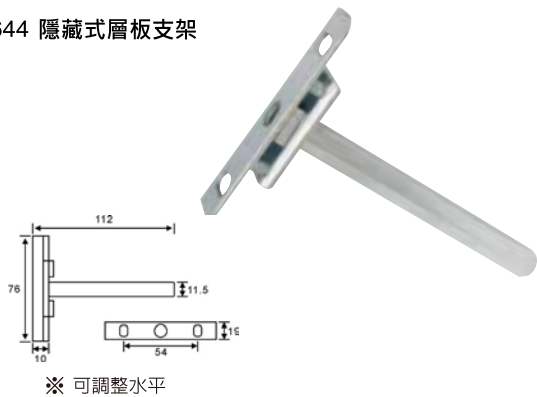

※ 可調整水平

L653 隱藏式層板螺絲

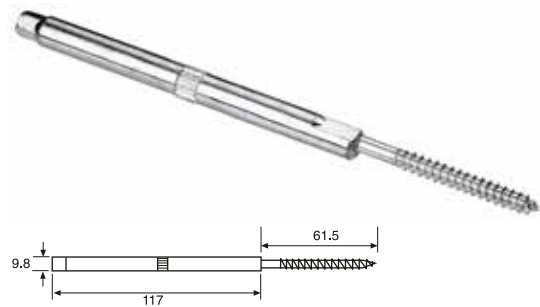

M3081 KD組合螺絲

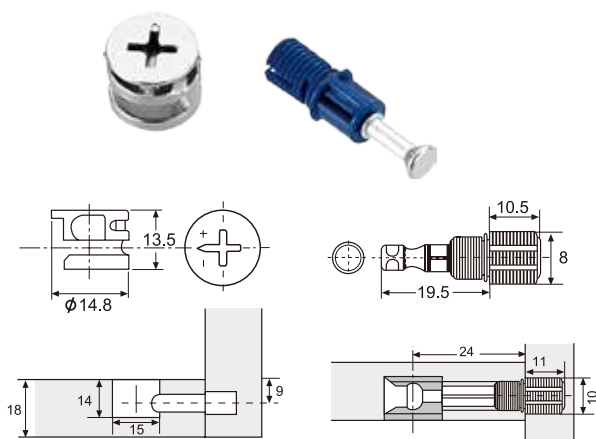

M3080 固格組合螺絲 ϕ 3mm

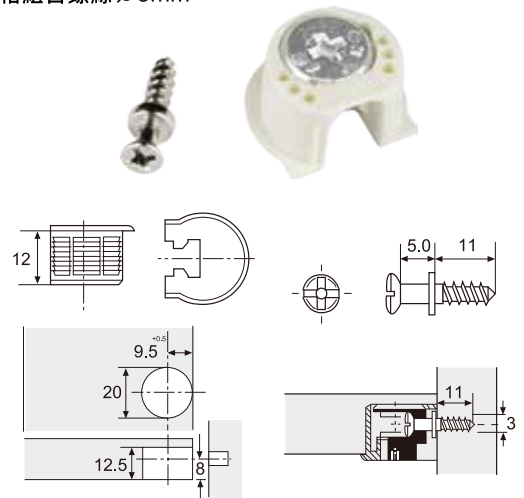

組合螺絲



Q11 Q4 Q15 (全組)

Q4尺寸齊全，訂購時請註明

組合螺絲



Q16 (全組)

Q13

Q17

Q9 Q10



各尺寸齊全

2分牙、2分半牙、無蓋

2分牙、2分半牙、有蓋

螺絲

Q19 Q20 Q25 Q21



滑軌螺絲
(4分)

鉸鏈螺絲
(5分)

大扁粗牙

正面鎖螺絲
(8分)

ES04-2 毛刷條



825尺/捆

ES05 保鮮膜



K043 美式穀倉門



K043P 美式穀倉門緩衝器



- ◆ 緩衝行程：10cm
- ◆ 承重：40-60KG

承載重量約90kg左右產品優勢如下：

- 1.可節省空間，穀倉門是牆面推拉式，可節省門片回轉的90度扇形空間。
- 2.造型美觀百搭，美式、簡約、北歐、中式、法式等所有風格，都可以與穀倉門搭配得宜。
- 3.可重複使用，穀倉門一般都會比門洞大，可重複利用性較高。
- 4.軌道長度：2米、2.5米(2種)
- 5.適用板厚：38~45mm
- 6.軌道下緣到天花板至少需要15cm空間才能安裝五金

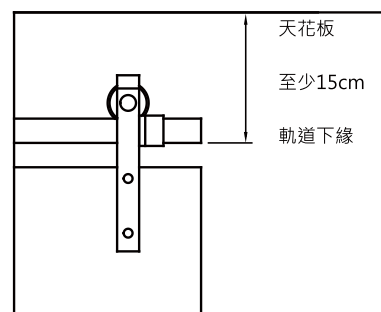

F31 圓型鋁腳粒



尺寸：∅51X高15mm
2分半牙X20mm

F30 方型鋁腳墊



尺寸：51X51X高25mm
可調整X10mm不鏽鋼腳粒

E26



500pcs / 包

	A	$\frac{1}{4}$ "
	B	$\frac{7}{8}$ "
	C	∅17 ∅19

E20



250pcs / 包

	A	$\frac{1}{4}$ "	$\frac{5}{16}$ "
	B	$\frac{4}{8}$ "	$\frac{5}{8}$ " $\frac{6}{8}$ " $\frac{7}{8}$ "
	C	∅35	

毛墊腳釘

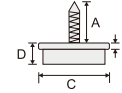

500pcs / 包

		L21	L22	L24
	A	15mm	15mm	15mm
	B	4.5mm	5mm	5mm
	C	∅20	∅22	∅28
D	9mm	10mm	10mm	

L01



1000pcs / 包

	A	6.5mm 8mm
	B	∅18 ∅18

L04

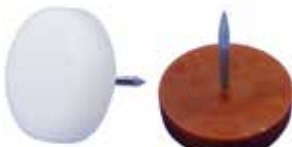

1000pcs / 包

	A	6mm 6mm 6mm 6mm
	B	∅21 ∅18 ∅15 ∅12

L10

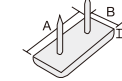

1000pcs / 包

	A	32mm
	B	12mm
	C	3mm

P01



1000pcs / 包

	A	∅35 ∅19
	B	15mm 9mm

E06



500pcs / 包

	A	$\frac{1}{4}$ "	$\frac{5}{16}$ "
	B	$\frac{7}{8}$ "	
	C	∅24	

E30A

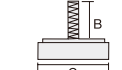

500pcs / 包

	A	$\frac{1}{4}$ "
	B	$\frac{7}{8}$ "
	C	∅17

B15 羊毛氈



Ø18x3mm



Ø25x3mm



Ø30x3mm



Ø35x3mm



Ø40x3mm

B37 防撞墊

以下適用20000小顆訂製品

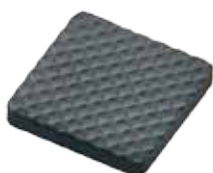

1A 25x25x4mm



1S 25x25x4mm



3S Ø20x2mm



4S Ø20x2mm



1S-1 15x15x1mm

B37 羊毛氈



2C Ø32x5mm



1C Ø25x5mm



3C Ø25x5mm



F Ø25x2mm



1B-1 Ø25x1mm



2B Ø20x2mm



4B-1 Ø22x1mm



F-1 Ø20x1mm



3B-1 Ø15x1mm



B-1 15x15x1mm



B 25x25x2mm



3B 25x25x2mm

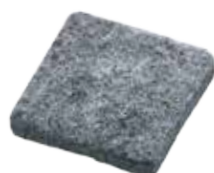

C 25x25x5mm



4B 20x20x2mm



1B 15x15x2mm

B35 防撞墊



10x10x3mm

B34 止滑墊



Ø20x1.5mm

B38 羊毛氈



厚度: 2mm
Ø20 Ø25 Ø30mm

B45 平面防撞墊



圓型: Ø18, Ø25, Ø32
Ø40, Ø55mm
方型: 18x18, 25x25
32x32mm

B44 壓紋防撞墊



厚度4mm
圓型: Ø18, Ø25, Ø32,
Ø55mm
方型: 18x18, 25x25,
32x32, 40x40mm

B46 羊毛氈



方型: 18x18x2mm 白
25x25x2mm 灰
25x25x5mm 黑
32x32x2mm 米白
32x32x5mm 棕
40x40x2mm 棕
40x40x5mm 黑
55x55x5mm 棕
圓型: Ø18x2mm 灰
Ø25x2mm 黑
Ø25x5mm 灰
Ø32x2mm 土黃
Ø32x5mm 米白
Ø40x5mm 米白
Ø55x2mm 黑
Ø55x2mm 灰

D09-20

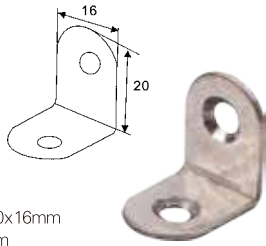

材質：#202
規格：20x20x16mm
厚度：2.0mm

D09-25

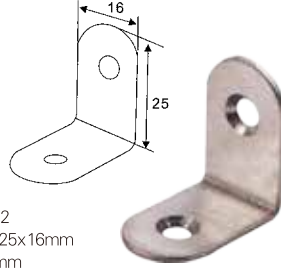

材質：#202
規格：25x25x16mm
厚度：2.0mm

D09-30

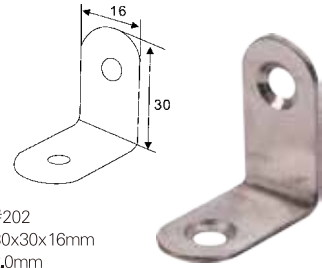

材質：#202
規格：30x30x16mm
厚度：2.0mm

D10

材質：#202
規格：
(D10-40-2)
40x40x17mm
厚度：2.0mm
(D10-40-3)
40x40x17mm
厚度：3.0mm
(D10-50-2)
50x50x17mm
厚度：2.0mm

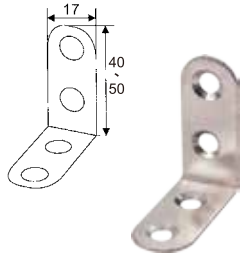

D11

材質：#202
規格：
(D11-50)
50x50x19mm
厚度：3.0mm
(D11-65)
65x65x19mm
厚度：3.0mm

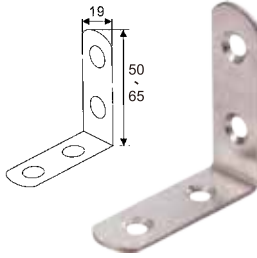

D11-80

材質：#202
規格：80x80x20mm
厚度：3.0mm

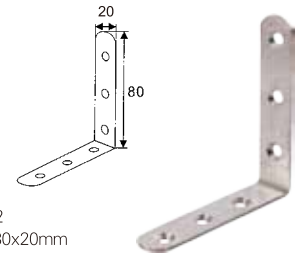

D11-100

材質：#202
規格：100x100x20mm
厚度：3.0mm

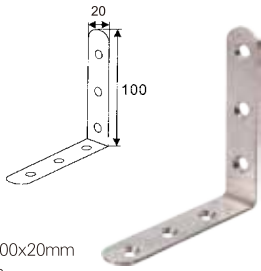

D11-125

材質：#202
規格：125x125x20mm
厚度：3.0mm

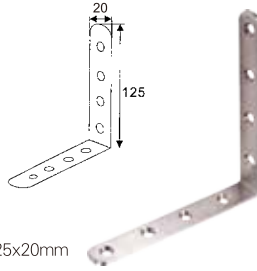

D12

材質：#202
規格：125x77x19mm
厚度：3.0mm

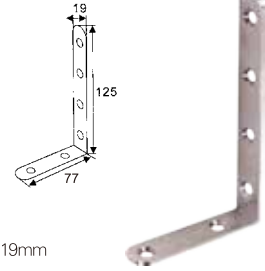

D13

材質：#202
規格：150x100x24mm
厚度：3.0mm (D13-3)
4.0mm (D13-4)

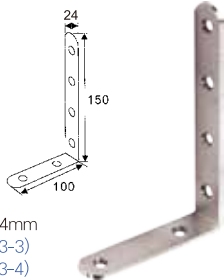

D14

材質：#202
規格：150x150x24mm
厚度：3.0mm (D14-3)
4.0mm (D14-4)

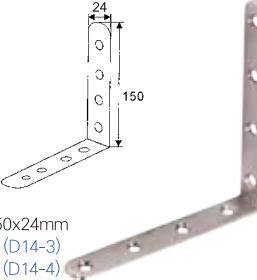

D15-50

材質：#202
規格：50x50x38mm
厚度：3.0mm

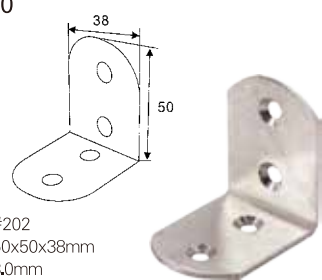

D15-65

材質：#202
規格：65x65x38mm
厚度：3.0mm

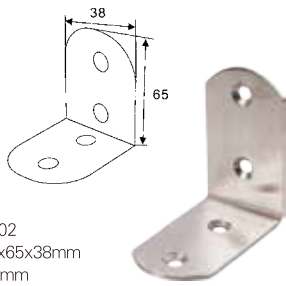

D15-85

材質：#202
規格：85x85x38mm
厚度：3.0mm

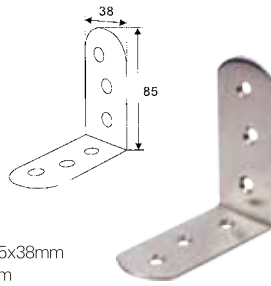

D16-50

材質：#202
規格：50x50x19mm
厚度：3.0mm

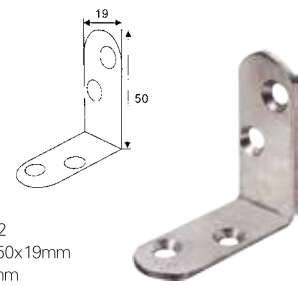

D16-65

材質：#202
規格：67x67x19mm
厚度：3.0mm

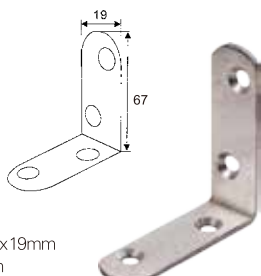

D16-90

材質：#202
規格：90x90x19mm
厚度：3.0mm

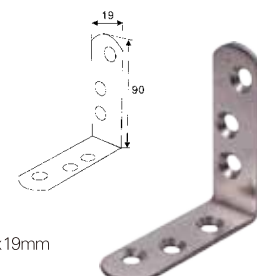

D17

材質：#202
規格：28x28x35mm
厚度：1.0mm

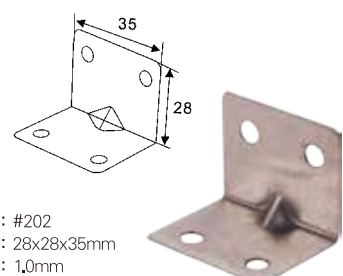

D18

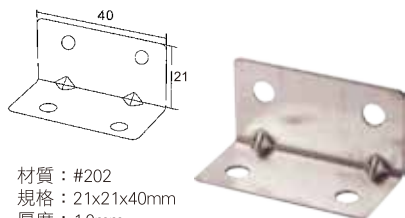

材質：#202
規格：21x21x40mm
厚度：1.0mm

D20

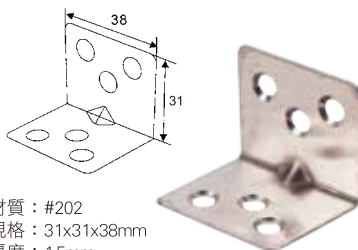

材質：#202
規格：31x31x38mm
厚度：1.5mm

D21

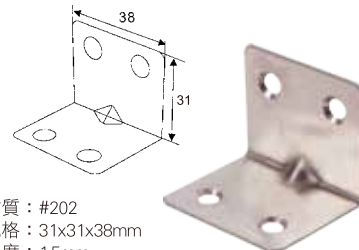

材質：#202
規格：31x31x38mm
厚度：1.5mm

D22

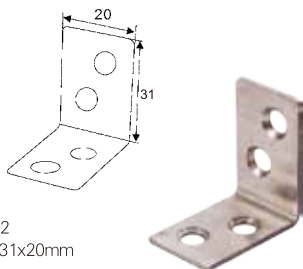

材質：#202
規格：31x31x20mm
厚度：2.0mm

D23

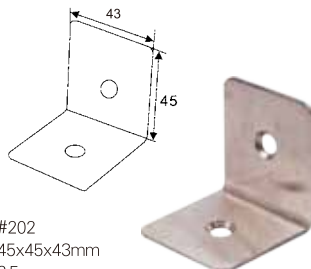

材質：#202
規格：45x45x43mm
厚度：2.5mm

D24-1.5

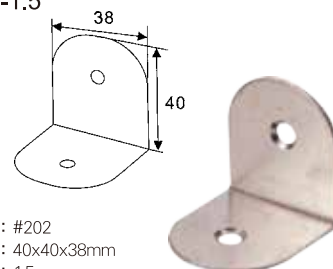

材質：#202
規格：40x40x38mm
厚度：1.5mm

D24-2

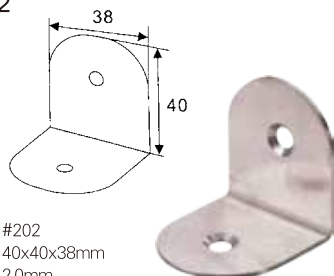

材質：#202
規格：40x40x38mm
厚度：2.0mm

D25

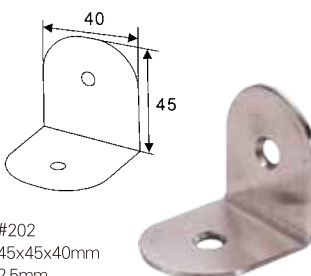

材質：#202
規格：45x45x40mm
厚度：2.5mm

D26

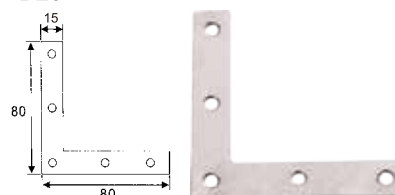

材質：#202
規格：80x80x15mm 厚度：1.0mm (D26-1)
厚度：1.5mm (D26-1.5)

D27-40



材質：#202
規格：40x40x15mm 厚度：1.0mm (D27-40-1)
厚度：1.5mm (D27-40-1.5)

D27-50



材質：#202
規格：50x50x15mm 厚度：1.0mm (D27-50-1)
厚度：1.5mm (D27-50-1.5)

D28

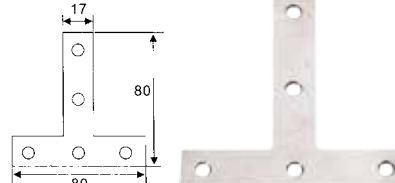

材質：#202
規格：80x80x17mm 厚度：1.0mm (D28-1)
厚度：1.5mm (D28-1.5)

D29

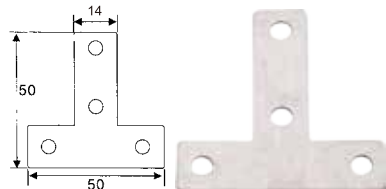

材質：#202
規格：50x50x14mm 厚度：1.0mm (D29-1)
厚度：1.5mm (D29-1.5)

D30

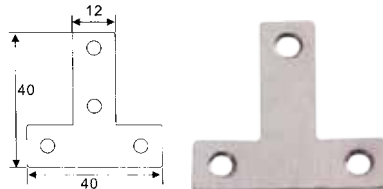

材質：#202
規格：40x40x12mm 厚度：1.0mm (D30-1)
厚度：1.5mm (D30-1.5)

D31

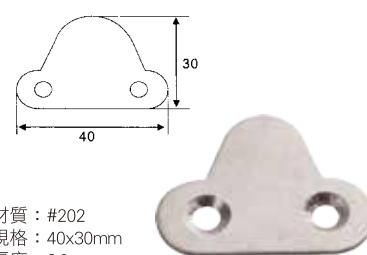

材質：#202
規格：40x30mm
厚度：2.0mm

D32



材質：#202
規格：57x16mm 厚度：2.0mm (D32-60)
47x16mm 厚度：2.0mm (D32-50)
38x16mm 厚度：2.0mm (D32-40)

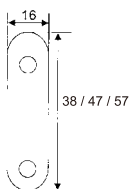

D33



材質：#202
規格：77x17mm 厚度：2.0mm (D33-80-2)
97x19mm 厚度：3.0mm (D33-100-3)
128x19mm 厚度：3.0mm (D33-125-3)

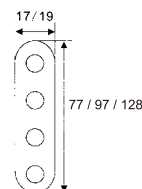





ES 歐式鋁框移門 吊門系列



玻璃 板材分隔方式

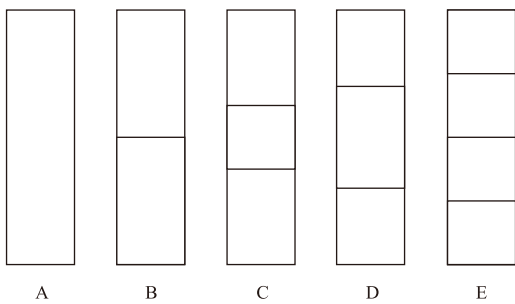

門片排列示意圖

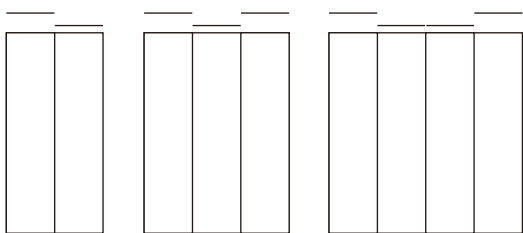

規格與選配事項

1. 玻璃適用：5、8、10 m/m 玻璃 及 5+3膠合玻璃。
2. 板材適用：5~9 m/m 貼合板、系統板、壓克力板等，另有六分板專用框型（P153~P154）。
3. 中間分隔條分為 8 m/m 窄板及 23 m/m 寬板兩種。
4. 落地型可選配緩衝型滑輪，提升門片推拉碰觸之質感。
5. 可加裝房間鎖或浴室鎖（適用AL029框型）。
6. 可選配連動效果（部份框型適用）。



AL029

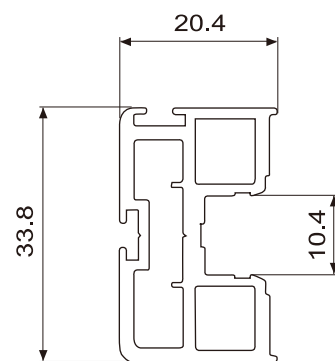

豎框

- 懸吊式
- 連動式
- 落地式
- 可裝鎖
- 可加裝把手(選購)



AL027

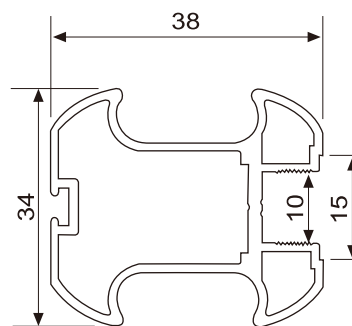

豎框

- 懸吊式
- 落地式



AL028

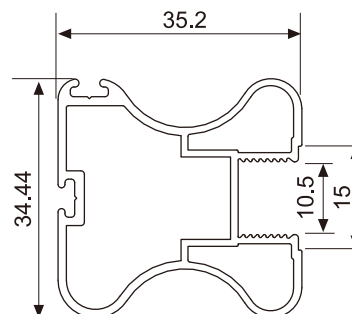

豎框

- 懸吊式
- 落地式



AL031

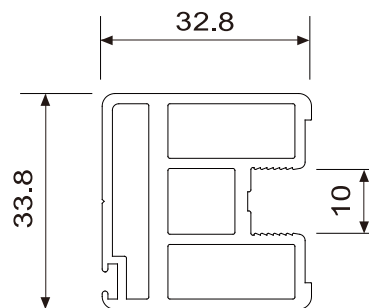

豎框

- 懸吊式
- 落地式
- 可加裝把手(選購)



AL218

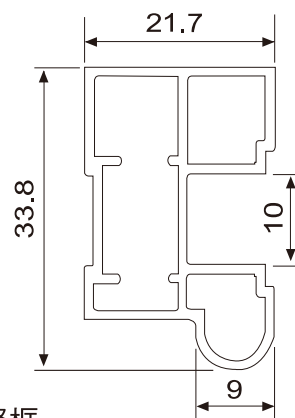

豎框

- 懸吊式
- 落地式



AL377

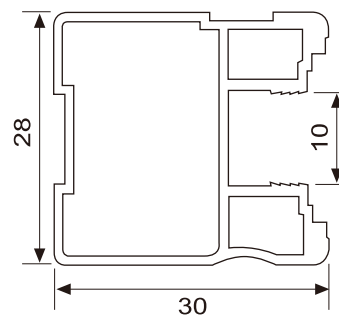

豎框

- 懸吊式
- 落地式



AL029

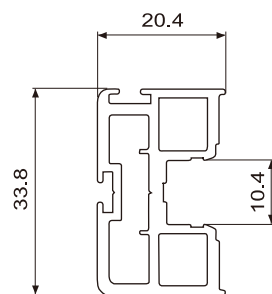

豎框

- 懸吊式
- 連動式
- 落地式
- 可裝鎖
- 可加裝把手(選購)



AL027

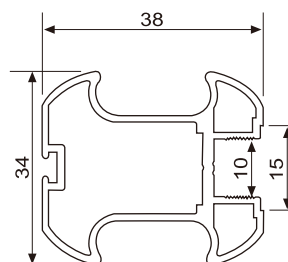

豎框

- 懸吊式
- 落地式

● 可選配 ●

K2930 浴室鎖 (70*70)



正面

背面

K2930-1 房間鎖 (70*70)

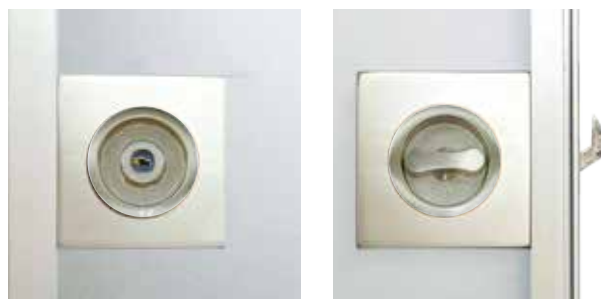

正面

背面







落地示意圖





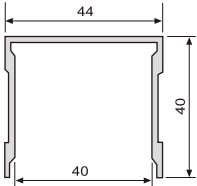
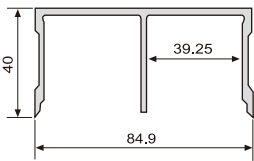
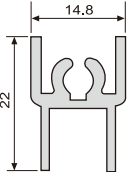

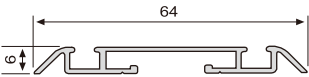
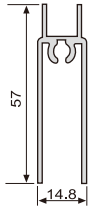
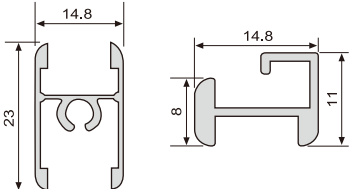
富苑設計

懸吊式示意圖

落地式 配件對照表

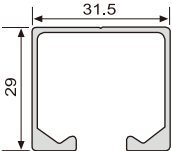
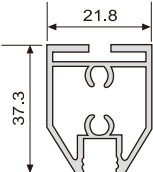
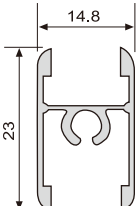
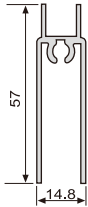
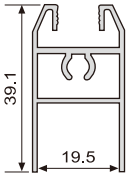
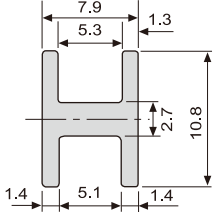
<p>上單軌 AL027-2C</p>	<p>上雙軌 AL027-2A</p>	<p>上框 AL027-7</p>
		
<p>下單軌 AL027-2D</p>	<p>下雙軌 AL027-2B</p>	<p>下框 AL027-6</p>
		
<p>區隔條 AL027-3 ALP363</p>	<p>緩衝型上輪+下輪 K022</p>	<p>歐式上輪+下輪 AL218-4</p>
		

懸吊式 配件對照表

<p>吊軌 K017A</p>	<p>上框 AL377-7</p>	<p>區隔條 AL027-3</p>
		
<p>下框 AL027-6</p>	<p>下框 AL377-6</p>	<p>H型區隔條 ALP323</p>
		
<p>配件 K028DW K037-4A</p>	<p>吊輪 K040 (快拆型)</p>	<p>吊輪 K021B (一般型)</p>
		

AL033 懸吊式

AL033 落地式(上下框型)

AL033 落地式(簡易型)

AL020 落地式(簡易型)







AL033 把手豎框



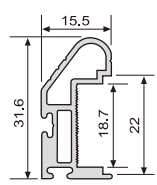
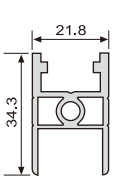
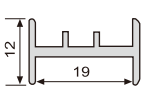
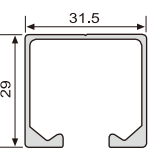
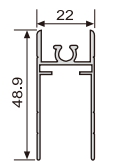
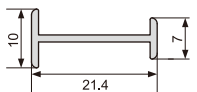

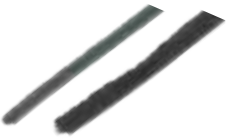
AL020 把手豎框

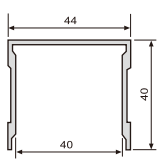
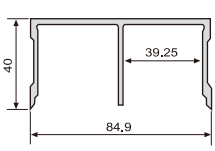
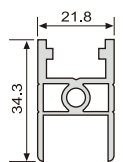
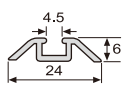
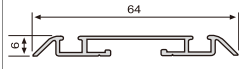
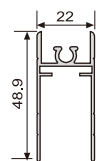
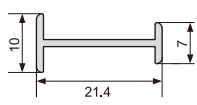
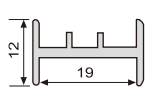

AL033 懸吊式

<p>豎框 AL033</p> 	<p>上框 AL033-7</p> 	<p>區隔條 ALP021</p> 
<p>吊軌 K017A</p> 	<p>下框 AL033-6</p> 	<p>區隔條 ALP416</p> 
<p>吊輪 AL033-4</p> 	<p>長、短毛刷條 (插鞘式)</p> 	<p>D、E 防撞條 (自黏式)</p> 

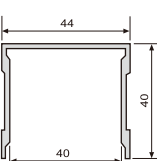
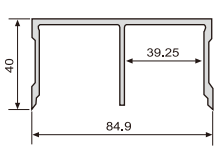
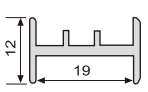
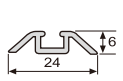
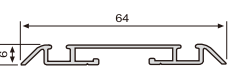
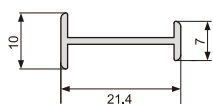
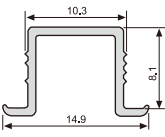
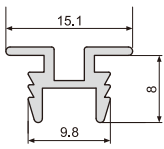

AL033 落地式 (上下框型)

<p>上單軌 AL027-2C</p> 	<p>上雙軌 AL027-2A</p> 	<p>上框 AL033-7</p> 
<p>下單軌 AL027-2D</p> 	<p>下雙軌 AL027-2B</p> 	<p>下框 AL033-6</p> 
<p>區隔條 ALP416</p> 	<p>區隔條 ALP021</p> 	<p>上輪+下輪 K029</p>  <p>(下輪售完停產)</p>

AL033 落地式 (簡易型)

<p>上單軌 AL027-2C</p> 	<p>上雙軌 AL027-2A</p> 	<p>區隔條 ALP021</p> 
<p>下單軌 AL027-2D</p> 	<p>下雙軌 AL027-2B</p> 	<p>區隔條 ALP416</p> 
<p>上單軌 K006</p> 	<p>下單軌 K006</p> 	<p>上輪 K026</p> 

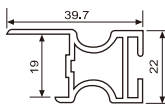
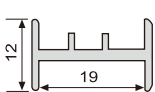
AL020 落地式 (簡易型)

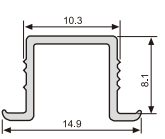
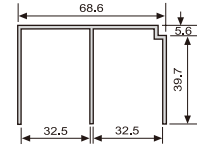
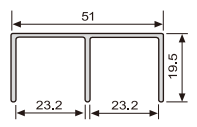
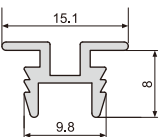
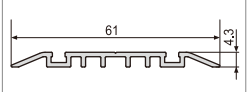
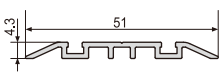
<p>豎框 AL020</p>  <p>背面木螺絲鎖入固定</p>	<p>區隔條 ALP021</p>  <p>溝槽深: 2(上) 5(下)</p>	<p>上輪</p> 
<p>上單軌 K006</p> 	<p>上雙軌 K020 8分板</p> 	<p>上雙軌 K020B 6分板(無豎框)</p> 
<p>下單軌 K006</p> 	<p>下雙軌 K020 8分板</p> 	<p>下雙軌 K020B 6分板(無豎框)</p> 

ES 鋁框 櫥櫃門系列



AL007



Color : 鋁色、黑色、亮白色



AL007 邊框

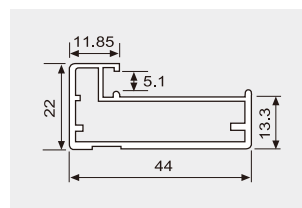

AL006 把手邊框

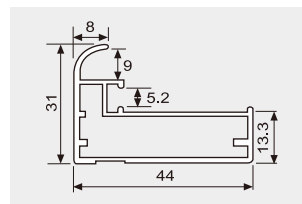

AL016



Color : 鋁色、黑色



AL016 邊框

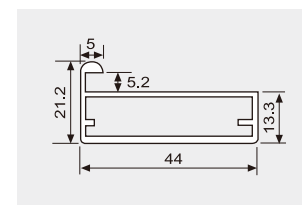

AL017 把手邊框

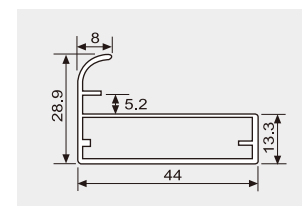

AL023



Color : 鋁色、黑色



AL023 邊框

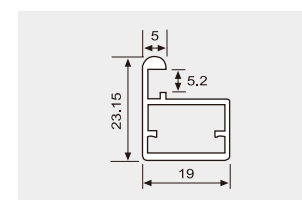

AL022 把手邊框

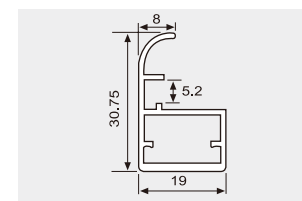

AL024



Color : 鋁色、黑色、亮白色



AL024 邊框

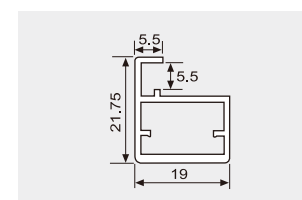

AL024-1 把手邊框 (無亮白色)

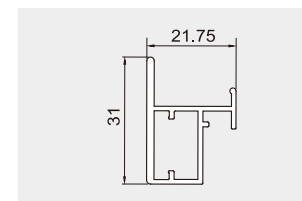

AL011

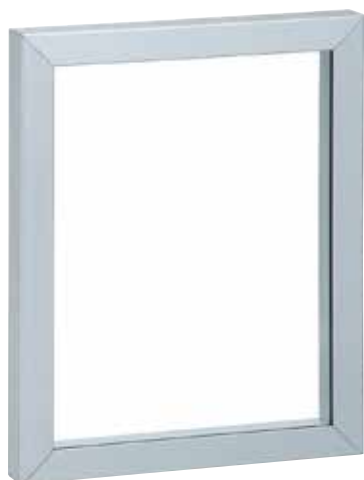

Color : 鋁色、黑色



AL011 邊框

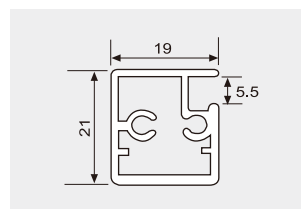

H15B 窄鋁框緩衝鉸鍊



適用型號 : AL011、AL023、AL024

AL023



Color : 鋁色、黑色



AL023 邊框

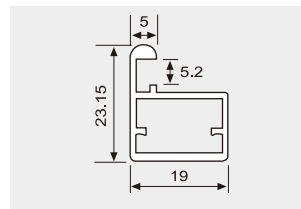

AL022 把手邊框

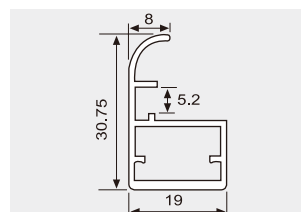

AL024



Color : 鋁色、黑色、亮白色



AL024 邊框

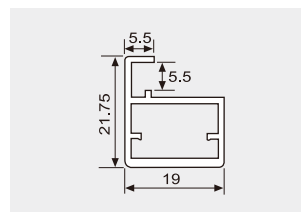

AL024-1 把手邊框(無亮白色)

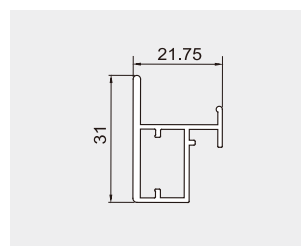

AL007



Color : 鋁色、黑色、亮白色



AL007 邊框

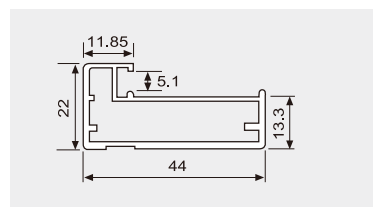

AL006 把手邊框

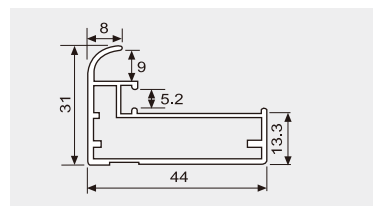

AL016



Color : 鋁色、黑色



AL016 邊框

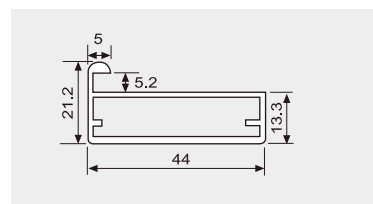

AL017 把手邊框

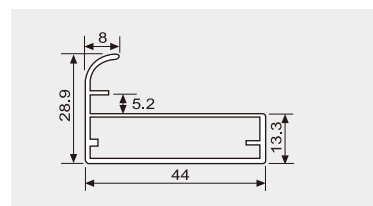

AL358-1



AL358 邊框

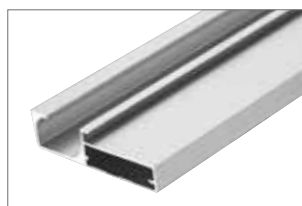
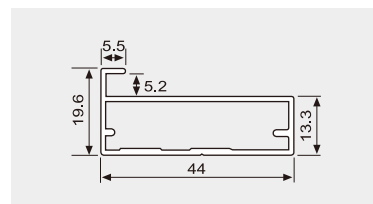

AL358-1 把手封邊

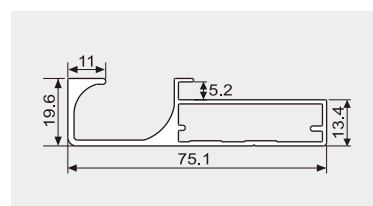

ALP323 H型區隔條

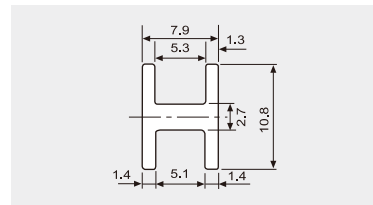

AL358



AL358 邊框

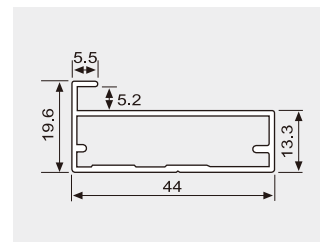

AL017 把手邊框

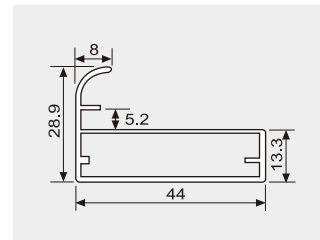

AL414



AL415 邊框

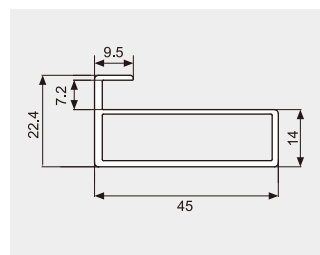

AL414 搭配用把手鋁框

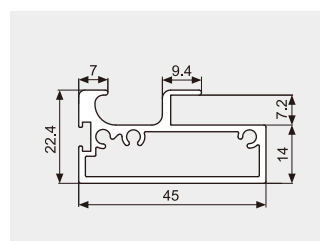

AL359



(背面)



AL359 邊框

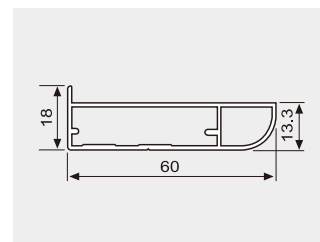

AL360



(背面)



AL360 邊框

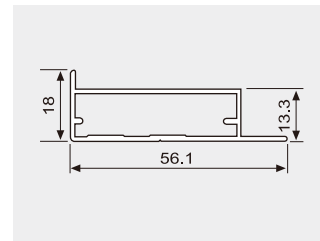

後面可夾12mm木板

459134 鋁封邊條

3米/支

459007 鋁封邊條

3米/支

459043 鋁封邊條

3米/支

459043B 鋁封邊條

3米/支 2.4米/支

459326

3米/支

10749

3米/支

12245

2.4米/支

10740

3米/支

10942

2.4米/支

10943

2.4米/支

10140

裝潢實心鋁條 10尺/支

10140-1

裝潢實心鋁條 10尺/支

618

6米/支

L613

6米/支

459-B0050

長度：250cm
裝潢實心鋁圓條

H12 上軌

3米/支

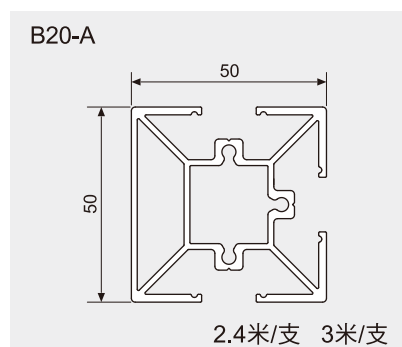
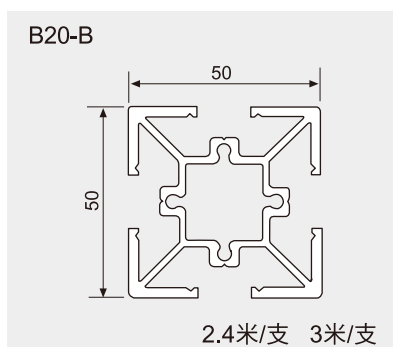
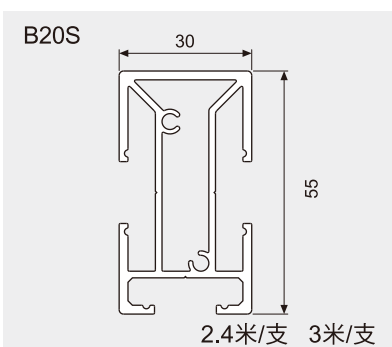
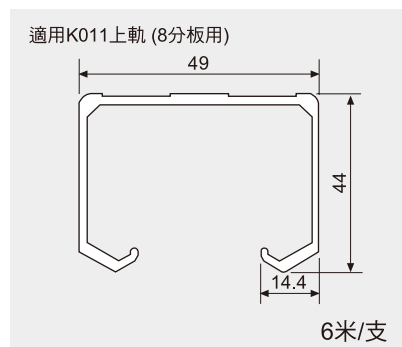
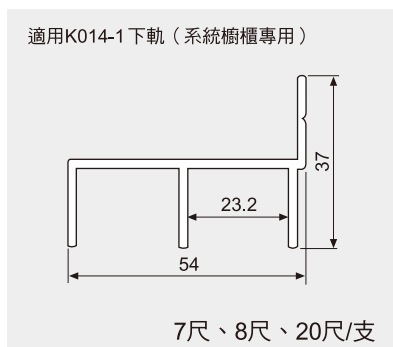
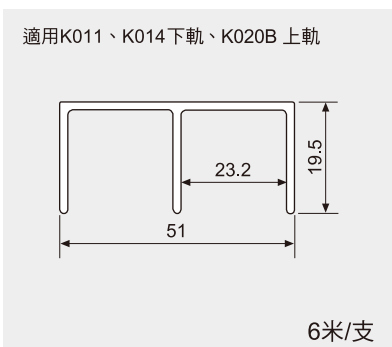
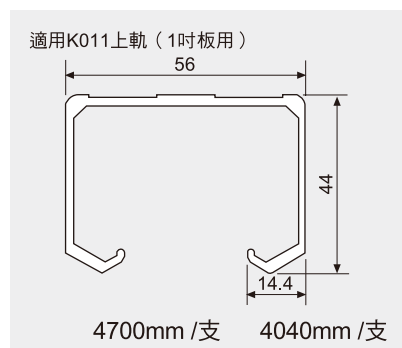
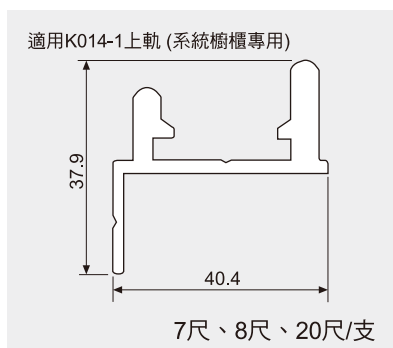
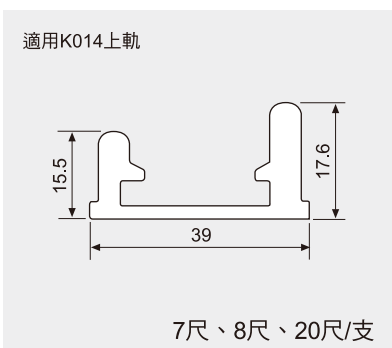
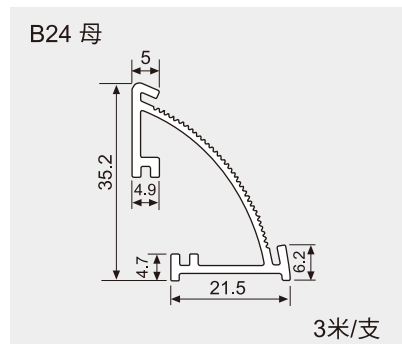
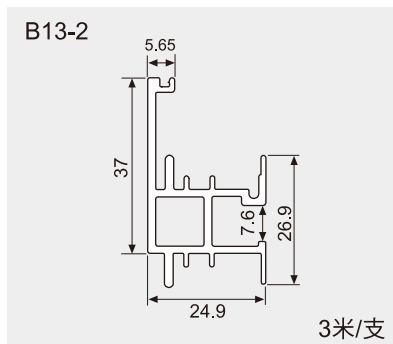
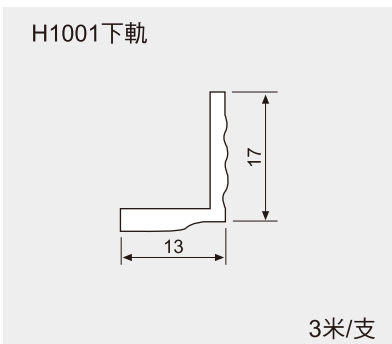
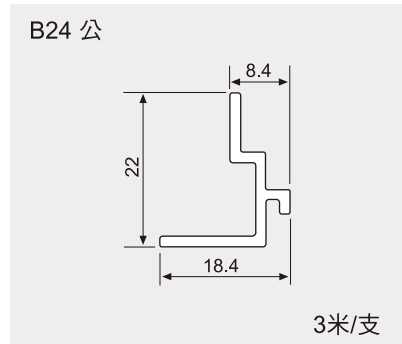
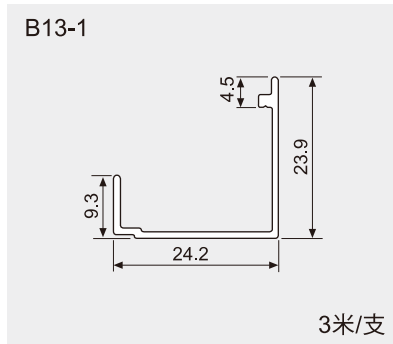
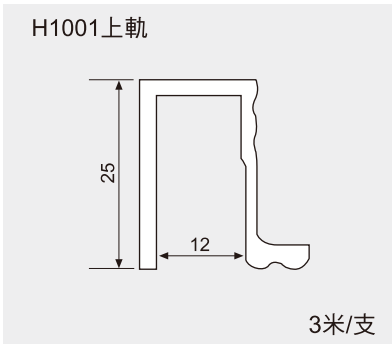

L5016 鋁管

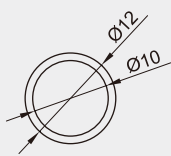

6米/支

L15C 鋁管

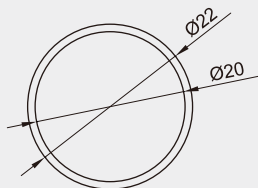

3米/支

F72 鋁管

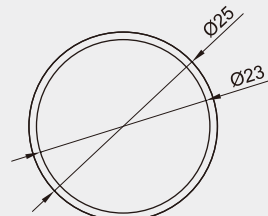

7尺/支

AF113-A

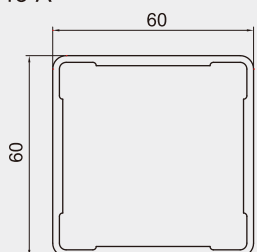

3米/支

AF113-B

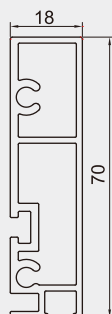

3米/支

AF113-C

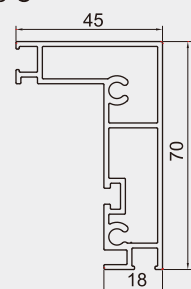

3米/支

B13-4

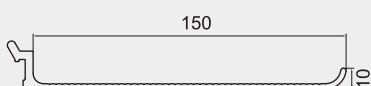

3米/支

B13-9

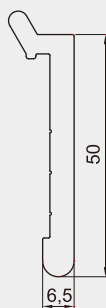

A052

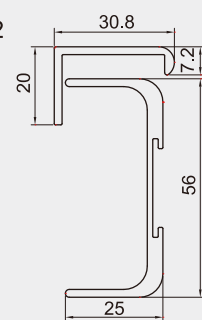

3米/支

K020 上軌

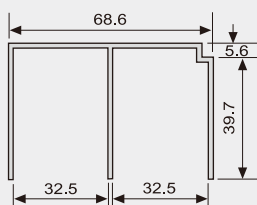

6米/支 6.2米/支

K020B 上軌

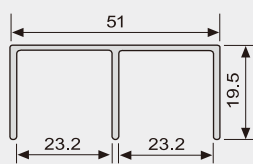

6米/支

AL027-2A 上軌

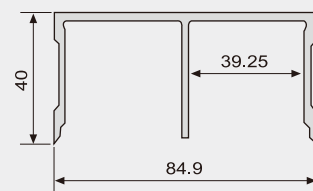

6米/支

K020 下軌

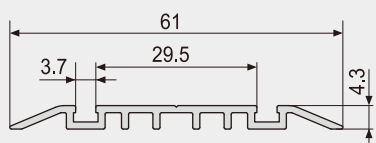

6米/支 6.2米/支

K020B 下軌

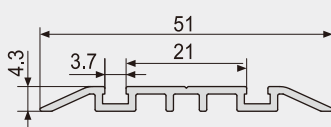

6米/支

AL027-2B 下軌

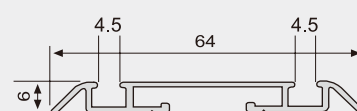

6米/支

單孔把手系列

ZC03 P.55,P.64
 ZC29 P.55,P.65
 ZC51 P.55,P.63
 ZH13 P.64
 ZH55 P.66
 ZCH04 P.47
 ZCH05 P.49
 ZCH06 P.47
 ZCH07 P.47
 ZS001 P.49
 ZS002 P.49
 AS003 P.45
 ZS003 P.45
 ES012 P.49
 ES014 P.45
 ZS022 P.49
 ZS025 P.49
 ES026 P.49
 ZS027 P.49
 ZS030 P.45
 ZS032 P.50
 ZS039 P.45
 ZS040 P.68
 AS041 P.50
 ZS045 P.47,P.68
 ZS047 P.68
 ZS048 P.68
 ZS051 P.49
 ZS055 P.47
 ZS057 P.47
 AS058 P.46
 AS059 P.7,P.9,P.46,P.50
 AS060 P.8,P.46,P.50
 AS063 P.8,P.9,P.46
 AS069 P.18
 AS070 P.18
 ZS071 P.69
 ZS075 P.47
 ZS076 P.46
 ZS077 P.45
 ZS078 P.47,P.63

ZS080 P.24,P.47,P.63
 ZS081 P.47
 ZS083 P.45
 AS084 P.45
 ZS087 P.47
 ZS088 P.48
 ZS089 P.48
 S091 P.50
 ZS092 P.46
 ZS093 P.45
 ZS095 P.46
 ZS096 P.46
 ZS097 P.46
 ES106 P.49
 ES119 P.48
 ZS120 P.49
 ZS125 P.48
 ZS126 P.18
 ZS128 P.48
 ZS129 P.48
 AS132 P.50
 ZS134 P.18
 ES136 P.18
 ZS137 P.48
 ZS138 P.48
 ZS142 P.48
 ZS144 P.48
 ZS148 P.48
 ZS149 P.18
 ZS153 P.7,P.41
 ZS154 P.41
 S155 P.54
 ZS156 P.13
 ZS157 P.53
 ZS158 P.54
 S162 P.51
 S163 P.51
 S164 P.51
 S165 P.51
 S166 P.51
 S167 P.51
 S168 P.51
 S171 P.51
 S172 P.51

S174 P.54
 S175 P.51
 S176 P.51
 S177 P.51
 ZS180 P.53
 ZS181 P.53
 ZS182 P.53
 ZS183 P.53
 ZS184 P.53
 ZS185 P.53
 ZS186 P.53
 ZS187 P.53
 ZS188 P.42
 ZS190 P.54
 ZS191 P.54
 ZS192 P.12
 AS193 P.54
 S194 P.55
 S195 P.14,P.55
 ZS198 P.57
 S199 P.50
 S200 P.50
 S208 P.52
 S209 P.52
 S211 P.52
 S212 P.52
 S213 P.52
 Z217 P.69
 S218 P.52
 S219 P.52
 S221 P.52
 S222 P.52
 S223 P.52
 S224 P.52
 S225 P.52
 ZS227 P.16,P.56
 ZS228 P.13
 ZS229 P.16
 ZS230 P.16

ZS231 P.16
 ZC233 P.56
 ZS234 P.56
 ZS235 P.56
 ZS236 P.12
 ZS237 P.54
 AS301 P.46
 AS302 P.46
 ZS303 P.60
 ZS304 P.12
 ZS312 P.60
 ZS316 P.60
 ZS322 P.60
 ZS323 P.60
 AS324 P.45,P.50
 ZS327 P.59
 ZS328 P.59
 AS333 P.50
 ZS334 P.24
 Z343-1 P.38
 S423 P.14
 S425 P.14
 S426 P.14
 S430 P.14
 S431 P.14
 ZS444 P.15
 ZS458 P.15
 ZS459 P.15
 ZS465 P.15
 Z515 P.17
 ZS908 P.49
 ZH911 P.45
 ZH912 P.45
 ZS910 P.57
 S955 P.14

雙孔把手系列

ZCH01 P.39
 ZL26 P.44
 ZL31 P.44
 Z35 P.32
 Z47 P.40
 Z76 P.29

雙孔把手系列

Z82	P.36	A394	P.20	Z508	P.33	Z587	P.24
ZL94	P.38	A395	P.20	Z509	P.50	A589	P.18
AL007	P.20	A396	P.24	Z510	P.17	A590	P.8,P.9,P.43
ZS124	P.18	A398	P.30	A512	P.29	Z591	P.33
ZS135	P.18	A400	P.22	A513	P.29	A592-1	P.17
Z201	P.40	Z402	P.35	Z515	P.17	A592-2	P.17
E206	P.40	A408	P.22	Z517	P.63	Z596	P.14
ZE213	P.69	A411	P.31	A518	P.10	Z597	P.14
Z226	P.36	A412	P.32	A519	P.7,P.10	A599	P.8,P.43
Z311	P.39	Z413	P.38	A520	P.10	Z641	P.43
Z314	P.36	Z415	P.38	A521	P.10	Z700	P.39
Z321	P.39	A416	P.37	A523	P.29	A701	P.17
Z332	P.39	Z417	P.38	A524	P.30	Z702	P.15
Z338	P.35	A432	P.23	A525	P.33	Z704	P.40
Z339	P.35	A433	P.30	Z526	P.33	A705	P.44
Z344	P.39	A434	P.21	Z527	P.43	Z706	P.15
Z345	P.36	A435	P.21	A530	P.32	Z709	P.15
Z348	P.44	Z436	P.63	A531	P.20	Z710	P.44
Z350	P.35	A437	P.22	A534	P.29	A711	P.19
Z351	P.39	A438	P.50	Z535	P.44	A711-1	P.19
Z352	P.38	A439	P.21	A536	P.37	A712	P.19
A357	P.8,P.43	A439-1	P.22	A537	P.35	A712-1	P.19
Z360	P.36	Z440	P.44	A539	P.10	A713	P.19
A367	P.22	A442	P.32	Z540	P.31	A713-1	P.19
A367-1	P.22	A450	P.30	Z541	P.37	A714	P.19
A367-2	P.21	A453	P.29,P.40	A542	P.22	A714-1	P.19
A367-3	P.21	Z463	P.38	A543	P.23	A715	P.32
Z369	P.36	Z464-32	P.37	Z544	P.33	A716	P.34
Z371	P.38	Z464-64	P.38	Z545	P.60	Z717	P.34
A372	P.23	Z466	P.38	Z546	P.12	Z718	P.40
Z373	P.63	ST467	P.31	A550	P.30	Z719	P.34
Z374	P.36	A468	P.17	A553	P.32	Z720	P.34
Z375	P.35	Z469	P.38	A558	P.4	Z725	P.7,P.41
A380	P.30	Z472	P.33	A558-1	P.3	Z726	P.41
A381	P.35	Z475	P.40	A559	P.7,P.9,P.10	Z727	P.42
A382	P.22	Z482	P.24,P.63	Z563	P.31	Z728	P.41
A382-1	P.21	ST486	P.31	A568	P.8,P.43	Z730	P.41
A382-2	P.21	Z487	P.40	A570	P.37	Z731	P.5
A383	P.23	Z491	P.31	A574	P.32	Z732	P.6
A387	P.20	ST492	P.31	Z581	P.60	A733	P.17
A388	P.20	Z495	P.29	Z582	P.60	Z734	P.54
		A504	P.37	Z585	P.59	A735	P.4
		Z506	P.33	Z586	P.59	A735-1	P.3

雙孔把手系列

Z736	P.54
Z737	P.13
Z738	P.13
Z739	P.13
Z741	P.42
Z742	P.42
Z743	P.42
Z744	P.63
Z745	P.63
Z746	P.5
Z748	P.61
Z749	P.55,P.57
A752	P.8,P.9,P.24
A753	P.7,P.9
Z754	P.13
Z755	P.13
Z756	P.13
Z757	P.13
Z758	P.53
Z759	P.53
Z760	P.6
Z761	P.42
Z762	P.42
Z764	P.5
Z765	P.5
A766	P.6
Z768	P.12
Z769	P.12
Z770	P.58
Z771	P.57
Z774	P.16,P.56
A776	P.32
Z777	P.16
Z778	P.16
Z779	P.43
Z780	P.43
A781	P.43
Z782	P.56
Z783	P.56
A784	P.30
Z785	P.12

Z786	P.25
Z787	P.11
Z788	P.11
Z789	P.11
Z790	P.11
Z794	P.54
Z806	P.13
Z853	P.57
Z854	P.57
Z856	P.57
Z858	P.57
Z859	P.57

古典把手系列

ZC01	P.64
ZC02	P.64
ZC03	P.55,64
ZC05	P.64
ZC06	P.64
ZC08	P.64
ZC09	P.64
C10	P.64
ZH13	P.64
ZC16	P.64
C18	P.64
ZC19	P.65
ZC21	P.65
ZC22	P.65
ZC23	P.65
ZC24	P.63
ZC25	P.65
ZC27	P.65
ZC29	P.55,65
ZC33	P.65
ZC34	P.65
ZC36	P.65
ZC38-M	P.65
ZC38-S	P.66
ZC39	P.66
ZC40	P.66
ZC42	P.66
ZC43	P.66
ZC47	P.66
ZC49	P.66
ZC51	P.55,63
ZH55	P.66

古典把手系列

EC60	P.57
ZC62	P.66
ZC64	P.67
ZC66	P.67
ZC67	P.67
ZC70	P.67, P.69
ZC73	P.67
ZC75	P.67
ZC76	P.67
ZC84	P.67
ZC88-M	P.67
ZC88-S	P.68
ZC89	P.68
ZC90	P.68
ZC92	P.68
ZC93	P.68
ZC94	P.68
ZC95	P.68
ZC97	P.68
ZC101	P.62
ZC102	P.62
ZC104	P.62
ZC107	P.62
ZC108	P.62
ZC109	P.62
ZC110	P.63
ZC111	P.61
ZC113	P.61
ZC114	P.61
ZC159	P.61
ZC160	P.61
ZC161	P.61
ZC162	P.61
EC196	P.58
EC197	P.58
ZE213	P.69
Z217	P.69
EC232	P.58
ZY10	P.69
ZY11	P.69
ZY14	P.69

ZY15	P.69
ZY17	P.69
ZY19	P.69
ZY20	P.70
ZY21	P.70
ZY22	P.70
ZY23	P.70
ZY24	P.70
ZY25	P.70
ZY26	P.70
ZY27	P.70
ZY28	P.70
ZY29	P.70
ZY30	P.70

嵌入式把手系列

ZCH02	P.25
AS061	P.26
ZS130	P.26
ZL231	P.27
ZL238	P.26
Z331	P.25
Z389	P.25
Z410	P.27
Z418	P.69
Z419	P.28
A443	P.26
Z474	P.26
Z479	P.26
A503	P.27
Z505	P.26
A571	P.28
A572	P.28
A580	P.28
Z703	P.28
Z722	P.41
Z724	P.28
ST747	P.25
Z748	P.61
A750	P.27
A795	P.27
A796	P.27
ZH914	P.27

